

BL 175/107 T > 13AN775G484 (2008) > GETRIEBE, VARIATOR

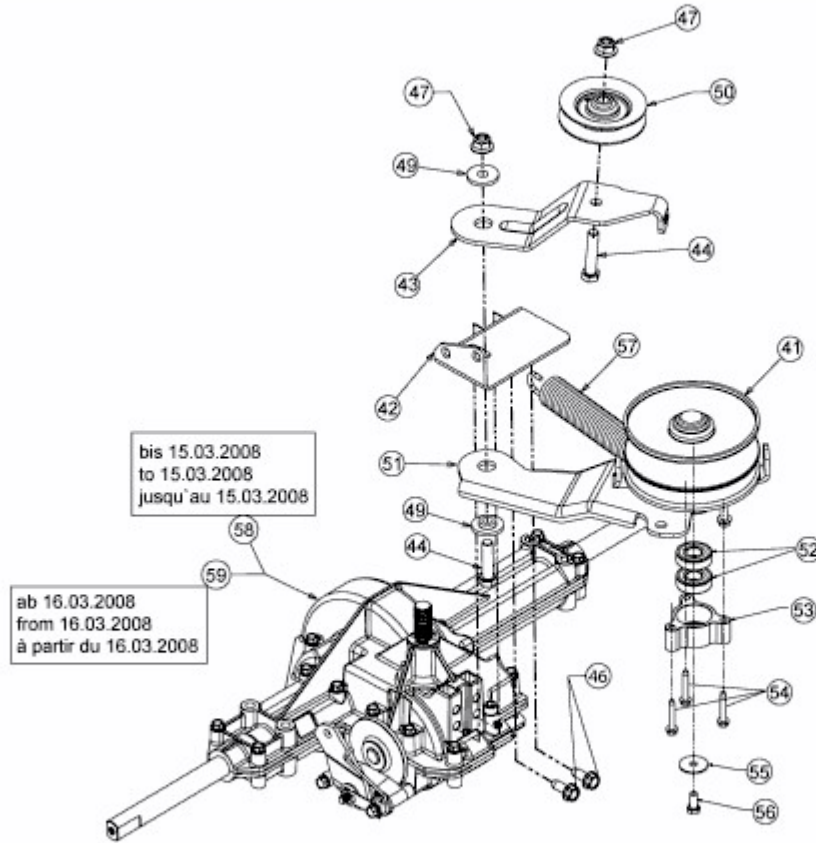

E3-02723C-02