

BL 175/107 T > 13AN775G484 (2008) > LENKUNG

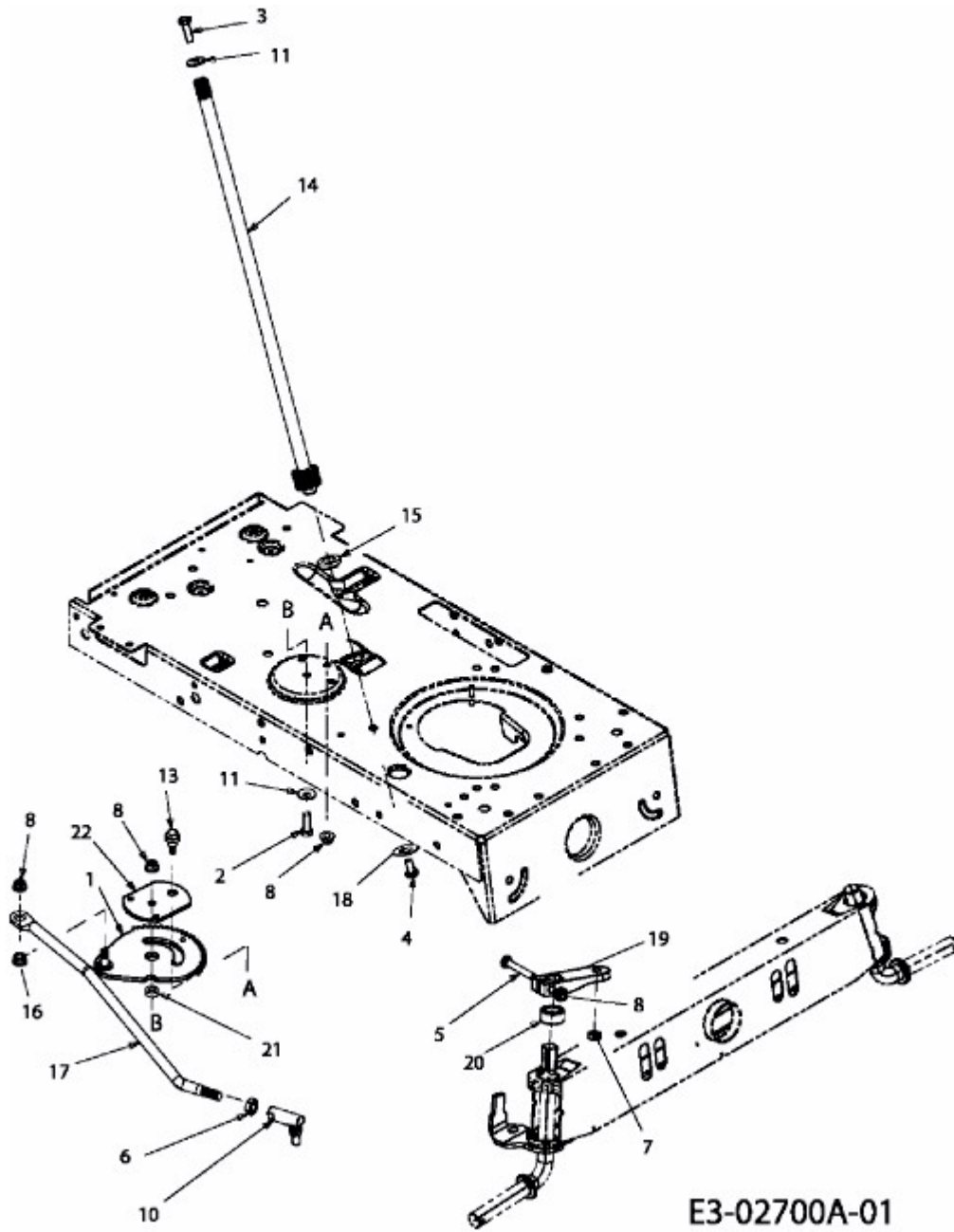

E3-02700A-01