

LG 175 > 13AN773G600 (2009) > GESCHWINDIGKEITSREGELUNG, PEDALE

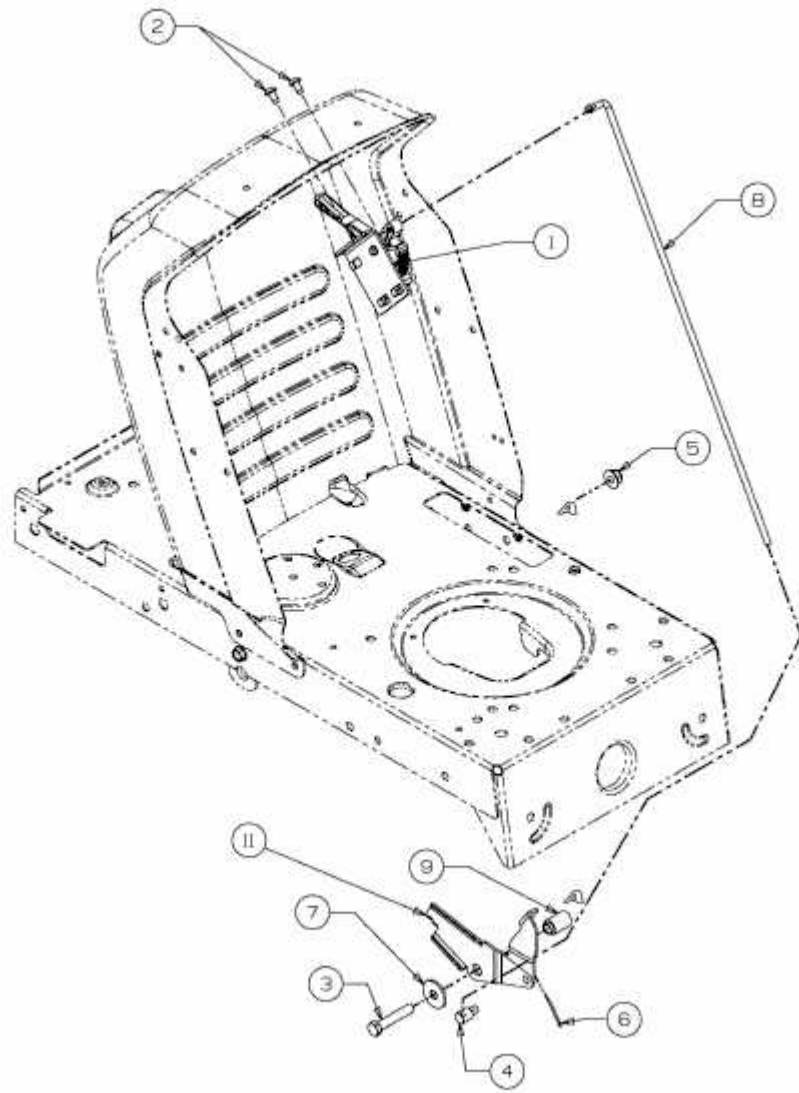

E3-02719C-01