

---

742 RL > 13AN772G029 (2009) > TRITTBRETTBELAG

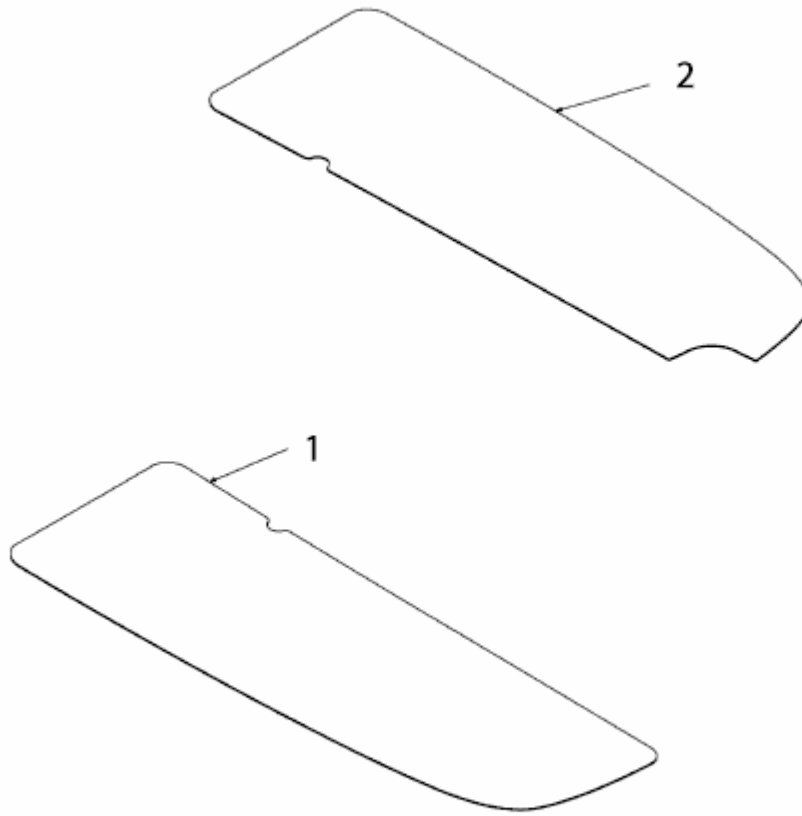

E3-02721A-01