

742 RL > 13AN772G029 (2009) > GESCHWINDIGKEITSREGELUNG, PEDALE

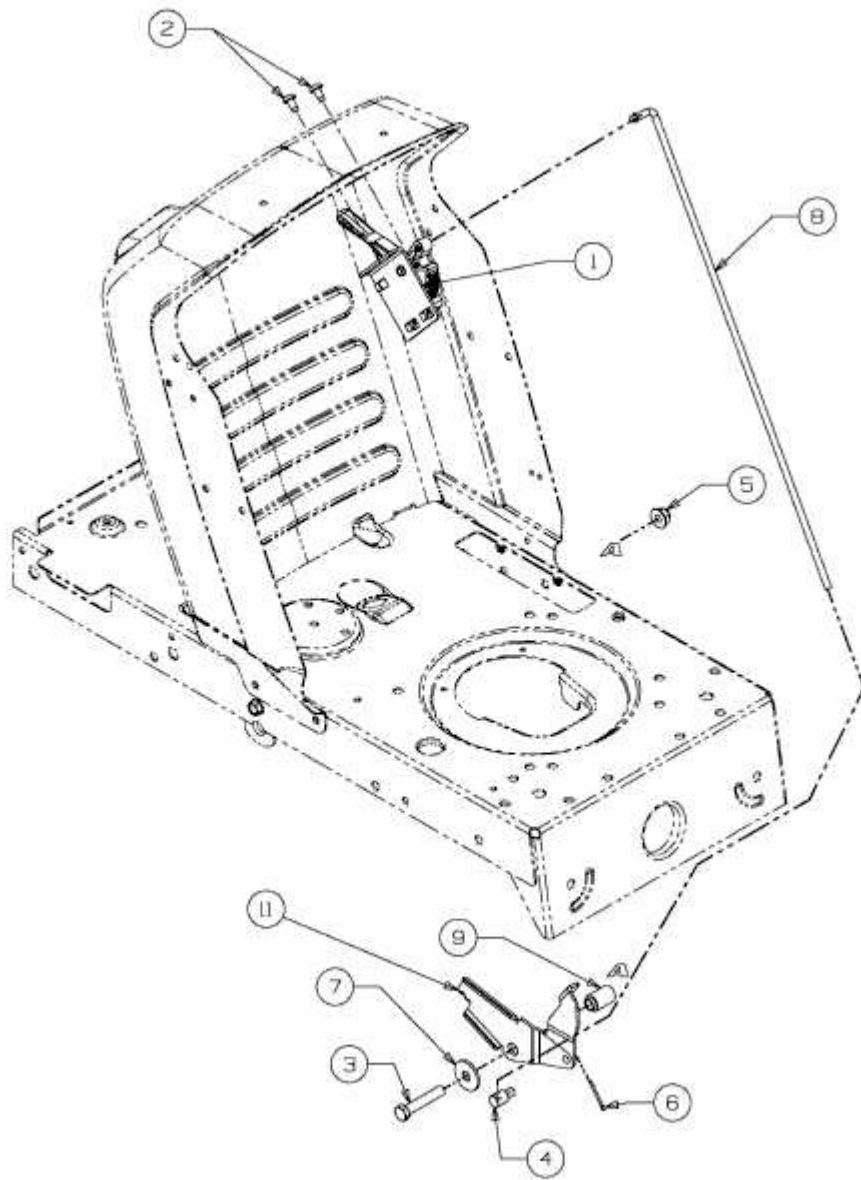

E3-02719C-01