

742 RL > 13AN772G029 (2009) > GETRIEBE, VARIATOR

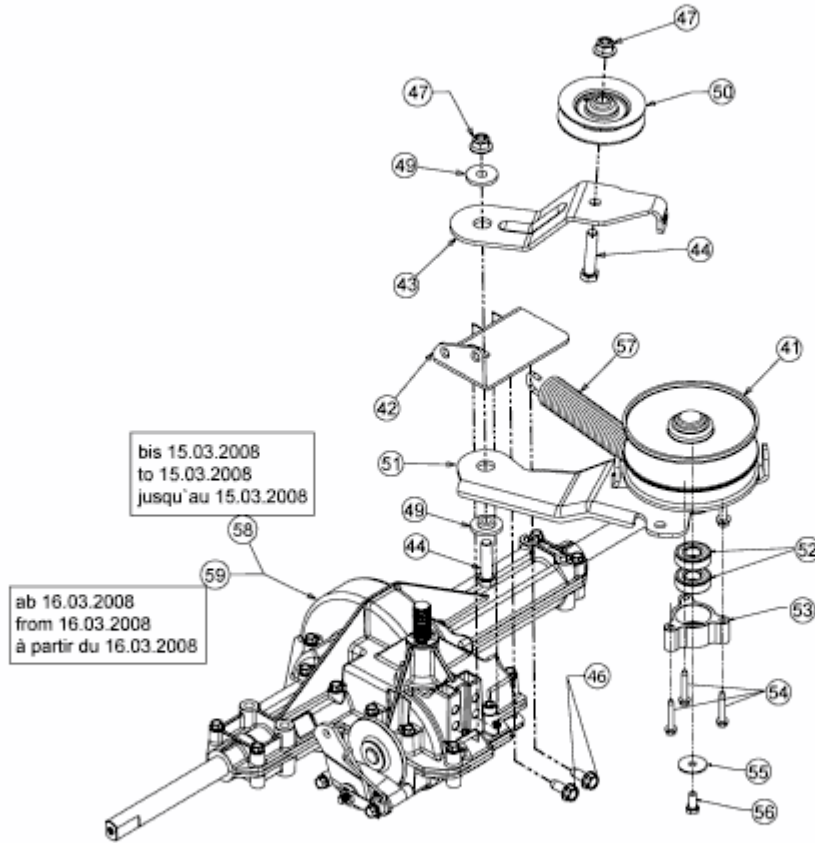

E3-02723C-02