

742 RL > 13AN772G029 (2009) > FAHRANTRIEB

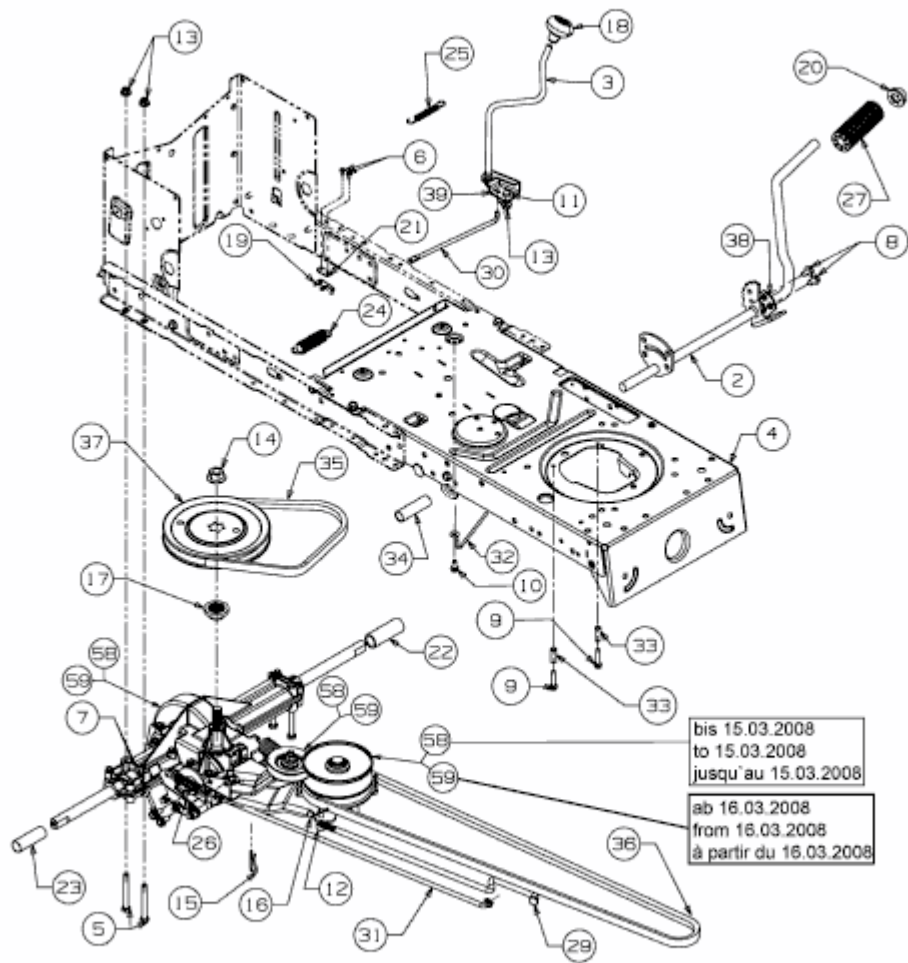

E3-02723C-01