

KROSSER PLUS 105/17,5 H > 13AN49KN636 (2010) > MOTORKEILRIEMENSCHLEIBE

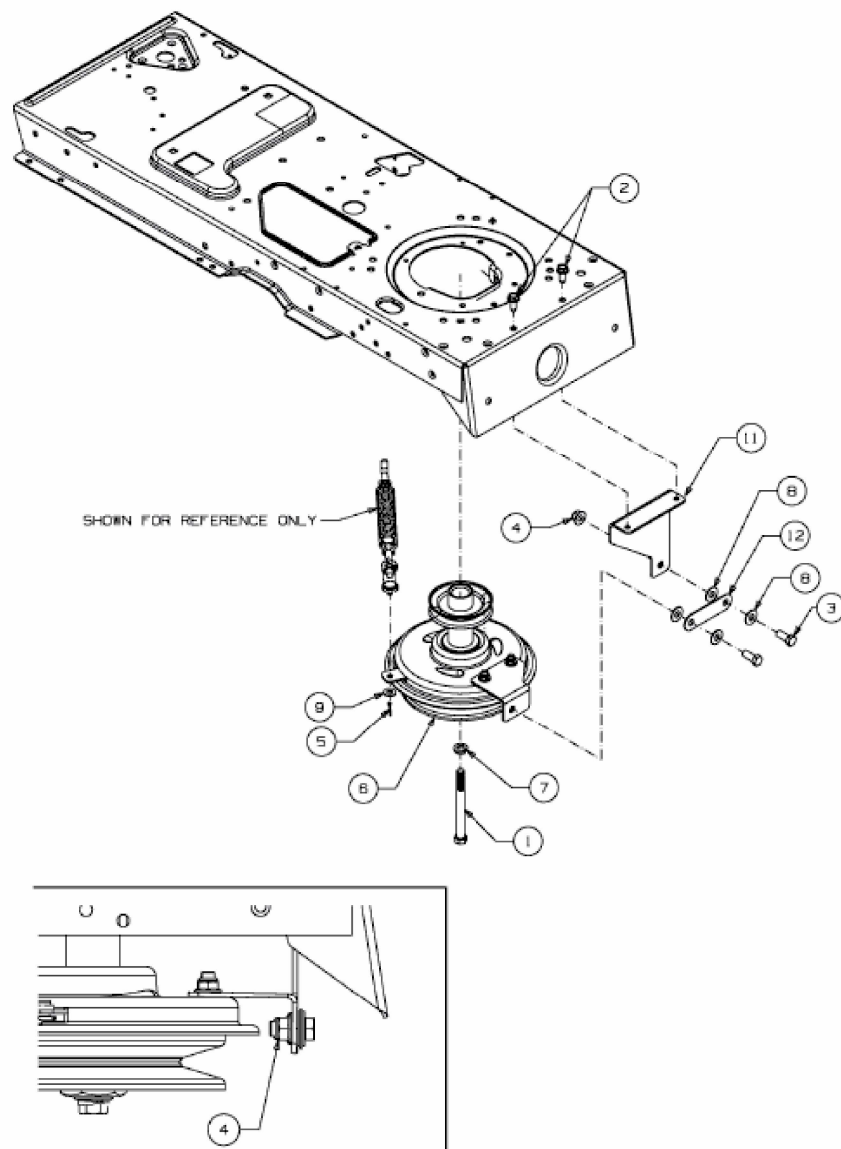

E3-05296A-01