

175/92 > 13AN487E615 (2010) > LENKRAD MIT LOGO

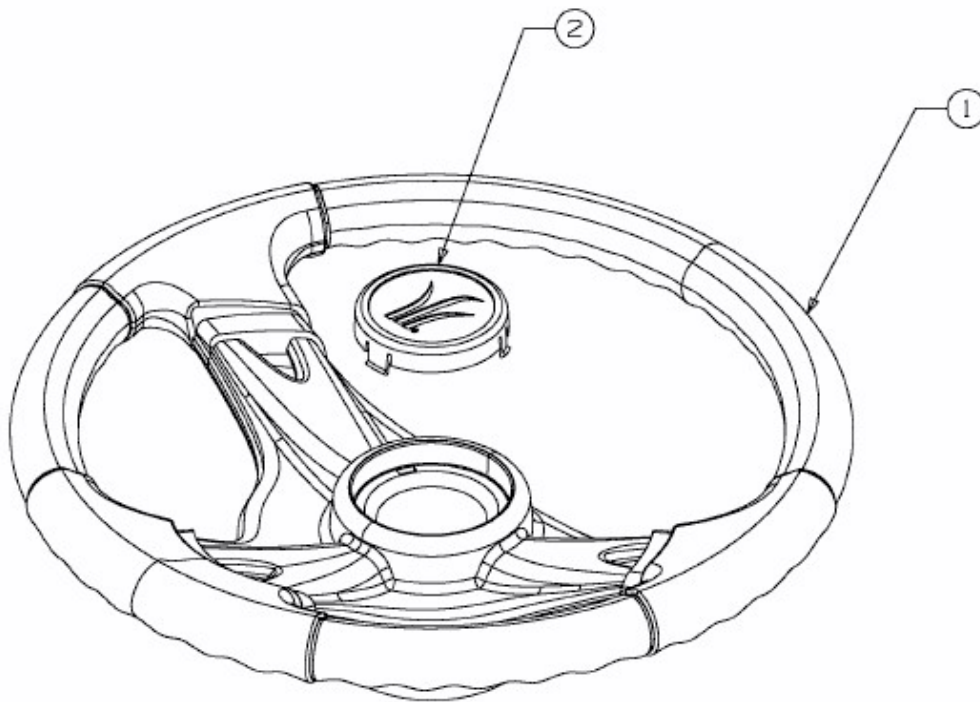

E3-02014A-01