

GL 15,5-105 H > 13AM993N640 (2012) > ABDECKUNGEN MÄHWERK N (41"/105CM)

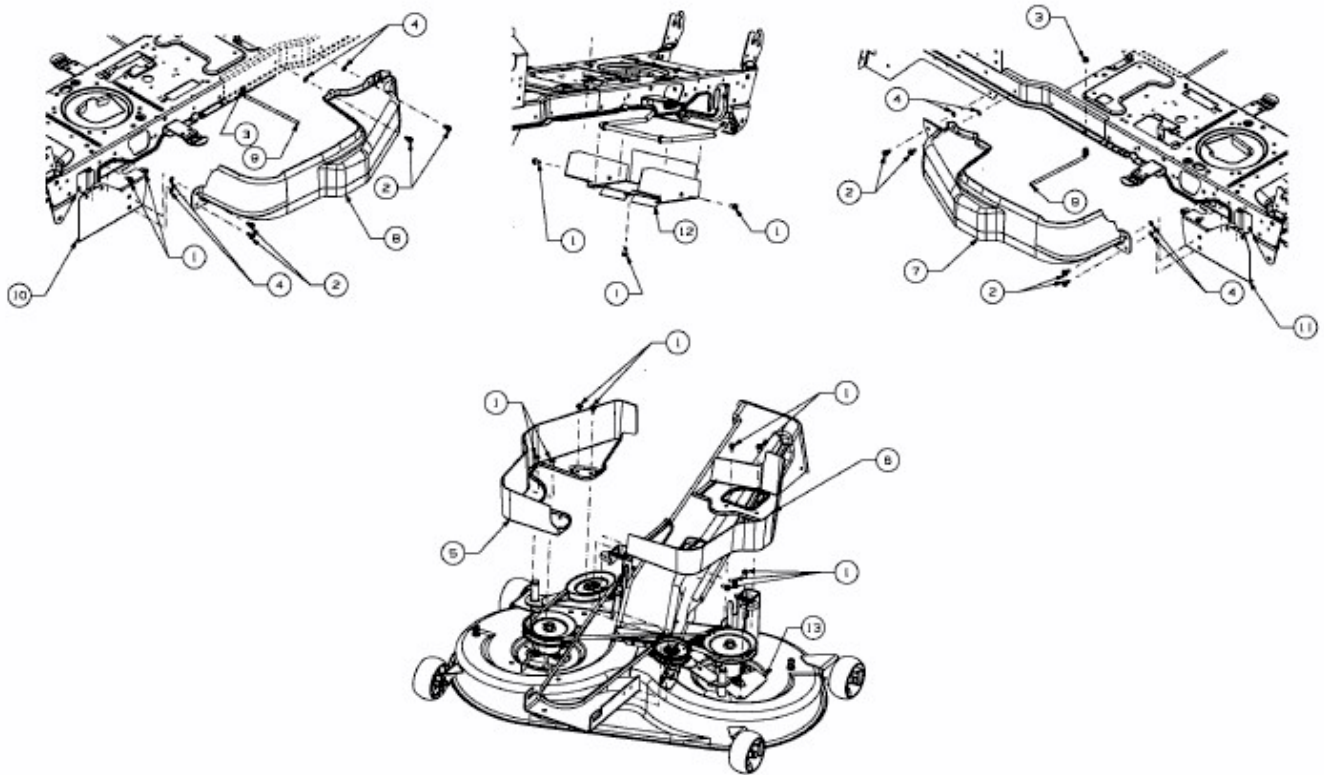

E3-07533A-01