

GL 15,5-105 H > 13AM993N640 (2012) > AUSGLEICHSBEHÄLTER, HYDROSTAT

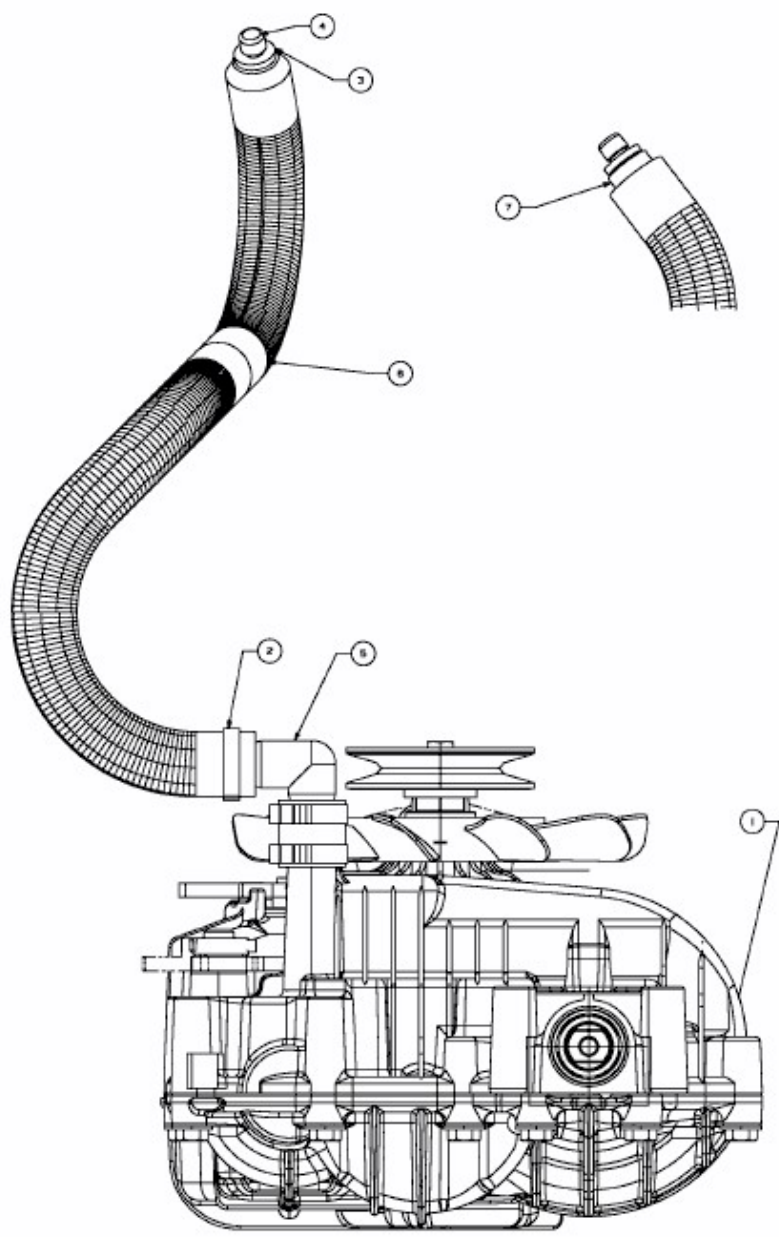

E3-07522A-02