

FORMULA 108/15.5 H > 13AM799G637 (2007) > DEFLEKTOR

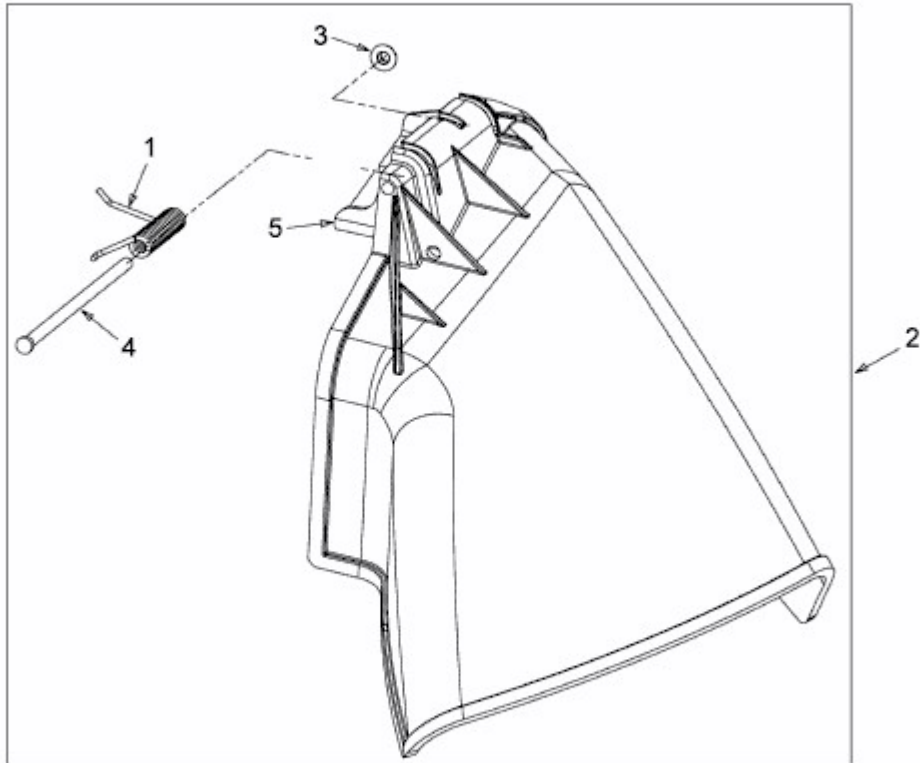

E3-02744A-01