

FORMULA 108/15.5 H > 13AM799G637 (2007) > HYDROSTAT

618-04198
348-0510

Nicht abgebildet/ Not Shown	
SEALANT	6
SEAL AND O-RING KIT	127

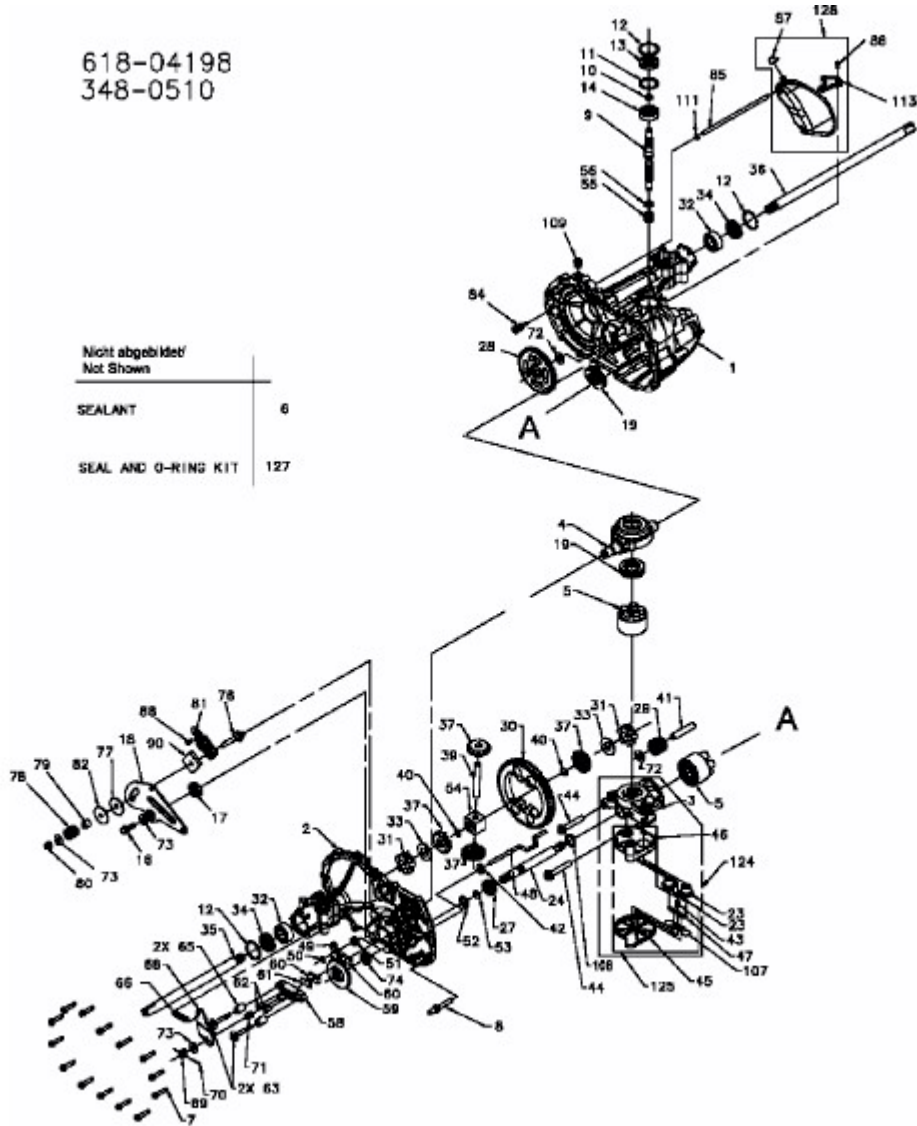

E3-02748A-01