

FORMULA 108/15.5 H > 13AM799G637 (2007) > ANTIRUTSCHBELAG

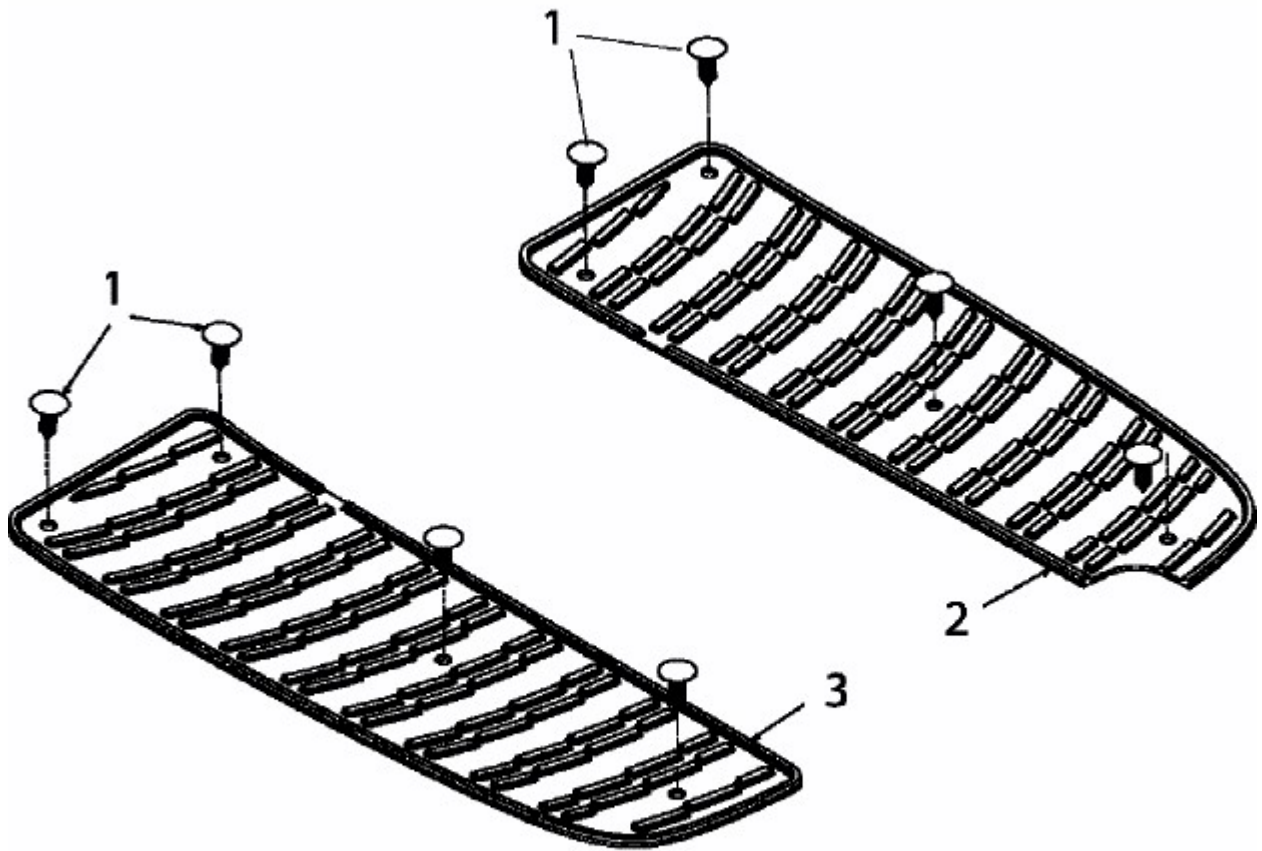

E3-02722A-01