

FORMULA 108/15.5 H > 13AM799G637 (2007) > LENKRAD

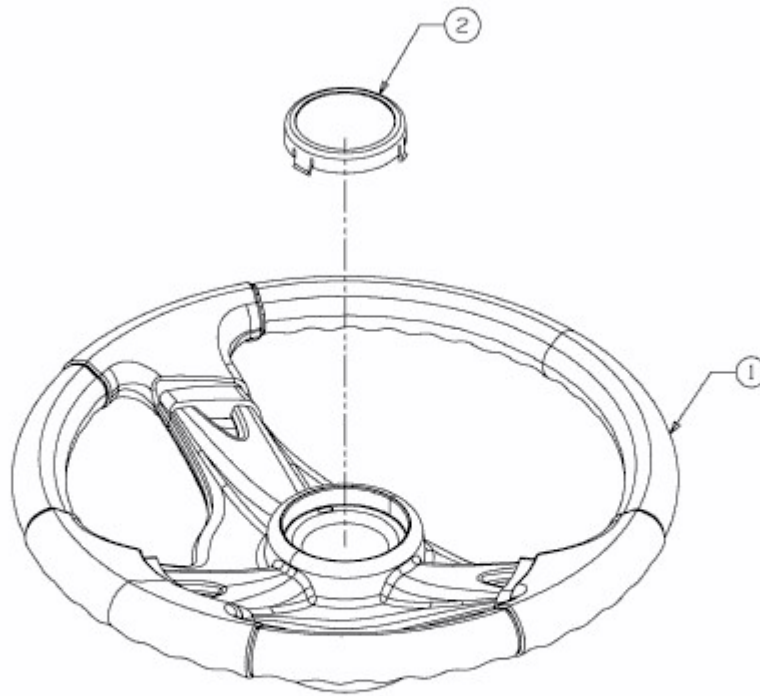

E3-02015A-01