

FORMULA 108/15.5 H > 13AM799G637 (2006) > MESSERSPINDEL 618-0624

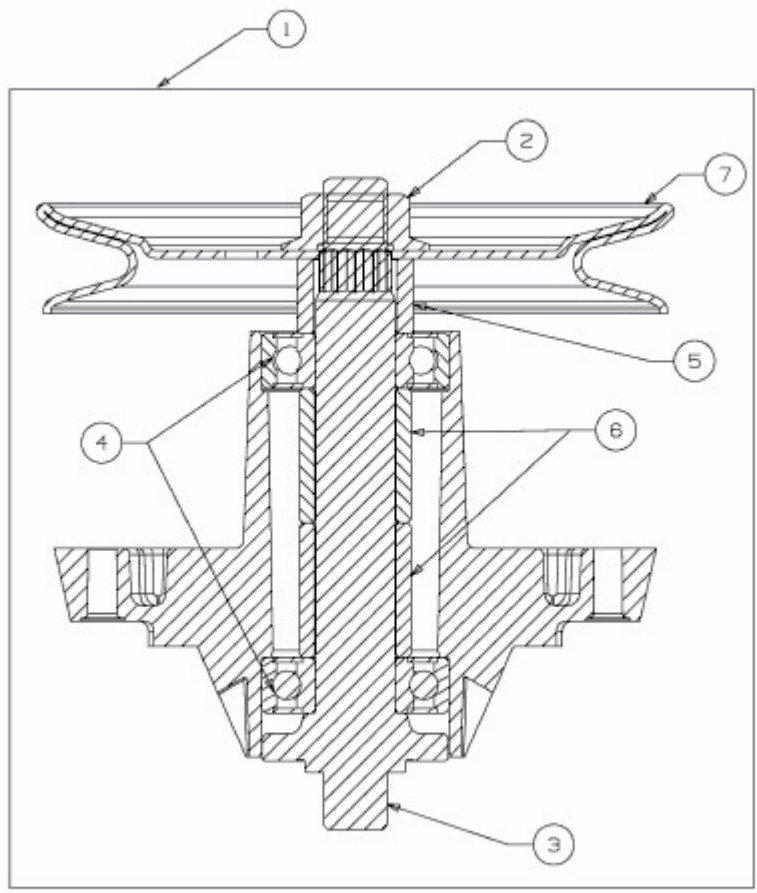

E3-01703A-01