

THROTTLE LIMITER TO BE
PLACE BETWEEN DASH
AND THE THROTTLE BRACKET.

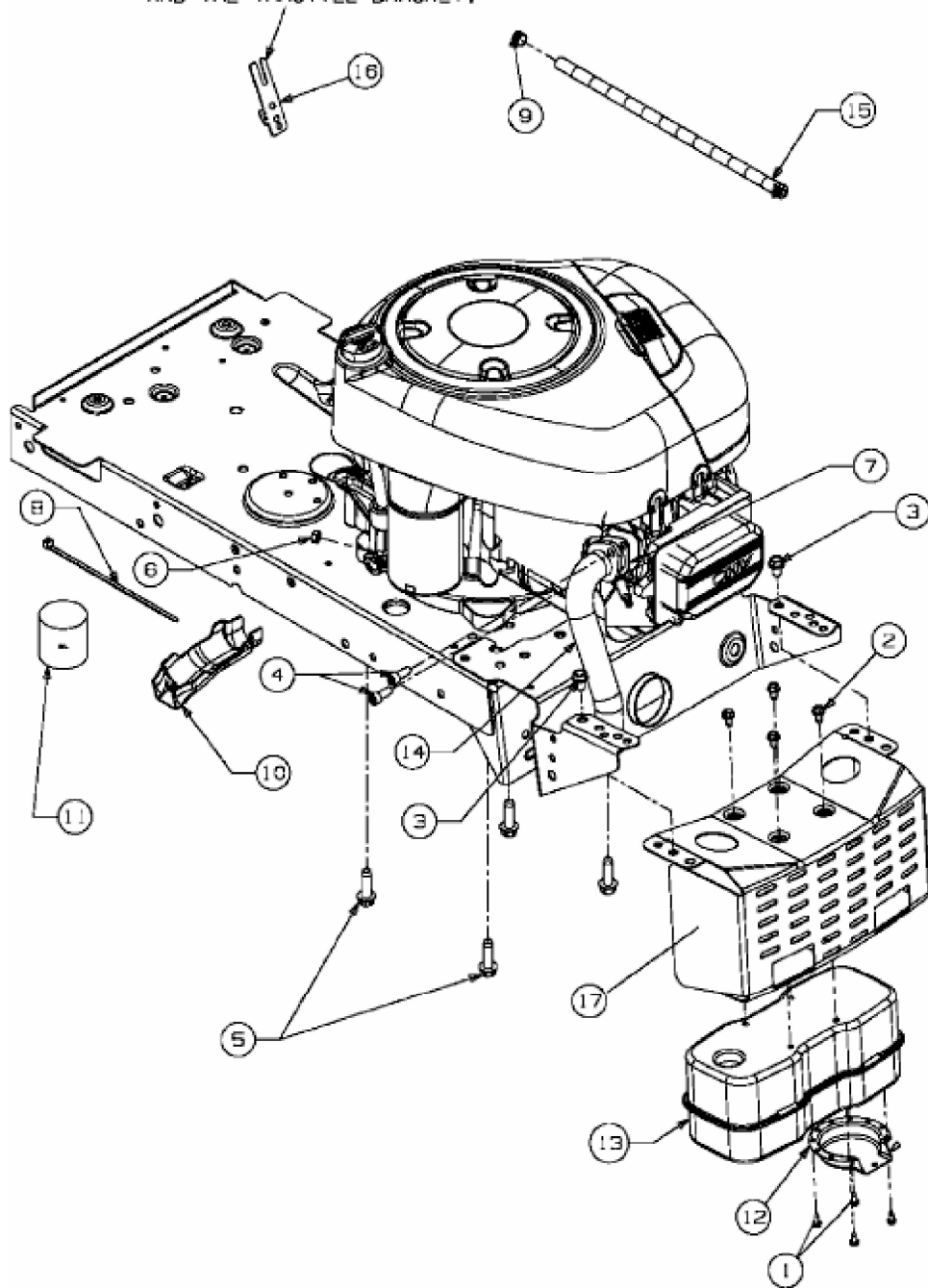

E3-03296A-01