

P 155 HF > 13AM793F678 (2008) > RAHMEN

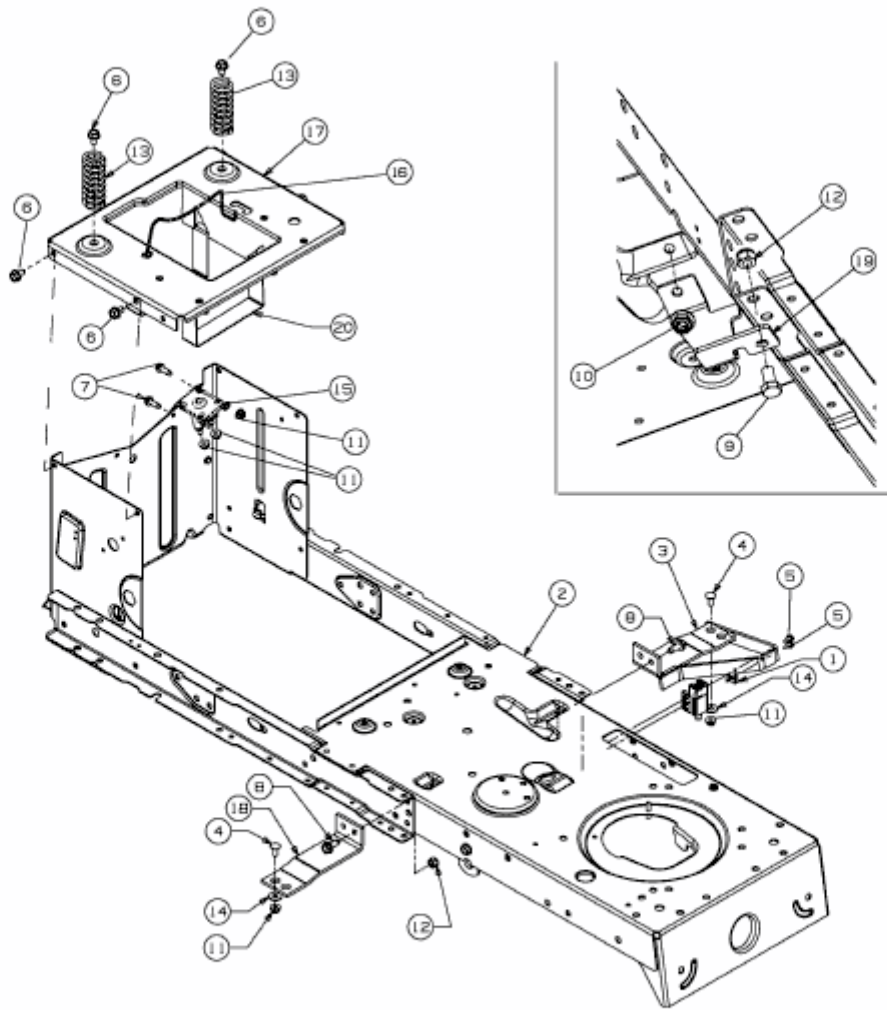

E3-02717B-01