

B 155/92 AM > 13AM788E683 (2009) > LENKUNG

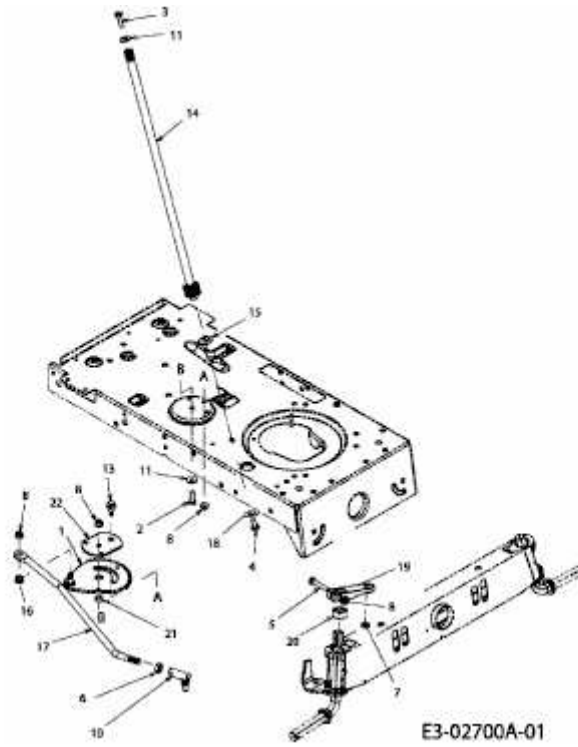

E3-02700A-01