

B 155/92 AM > 13AM788E683 (2008) > BATTERIEHALTER, TANK AB 25.02.2008

ab 25.02.2008
from 25.02.2008
à partir du 25.02.2008

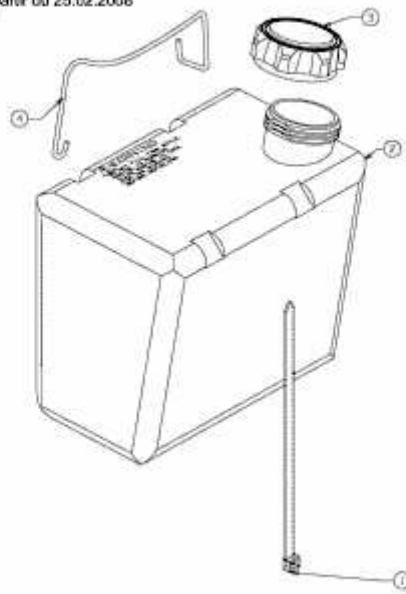

E3-02736D-01