

ab 16.06.2008
from 16.06.2008
à partir du 16.02.2008

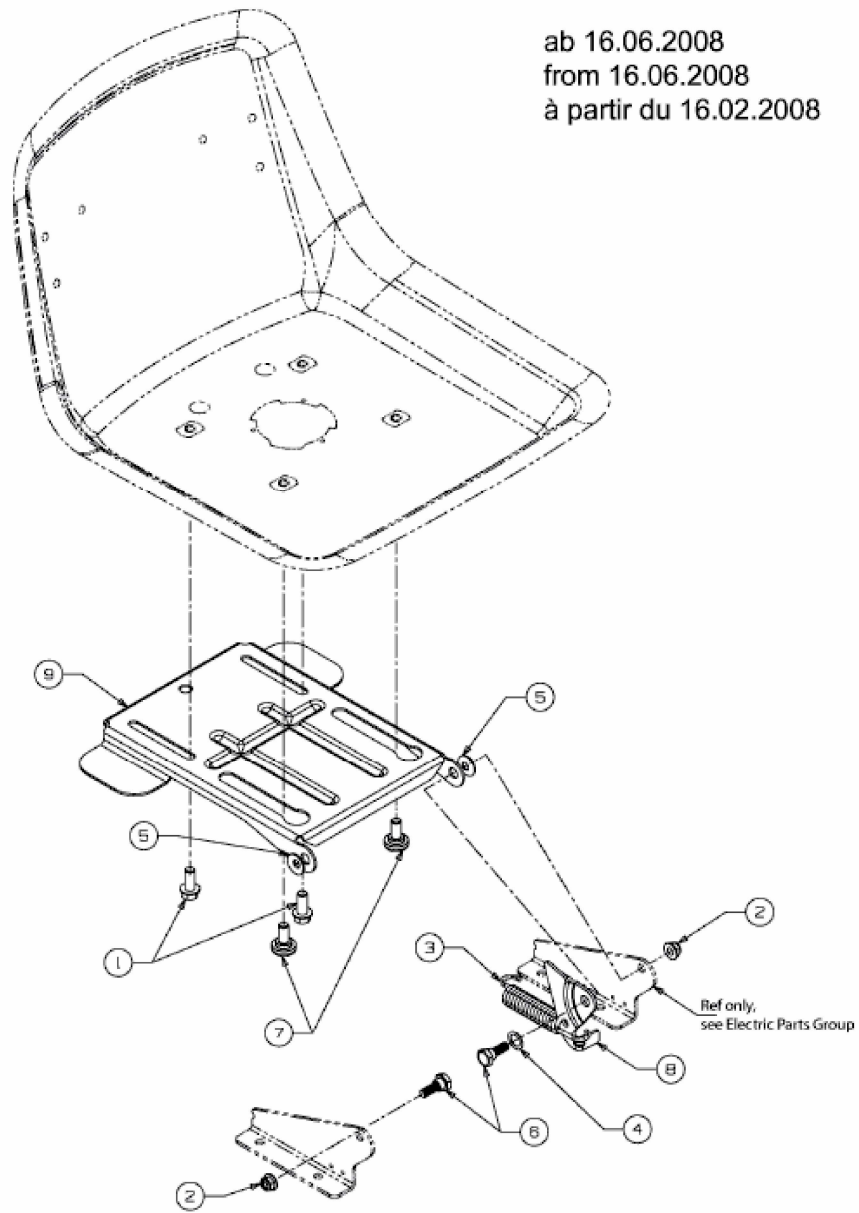

E3-04368A-02