

155-96 > 13AM777F615 (2010) > LENKRAD MIT LOGO

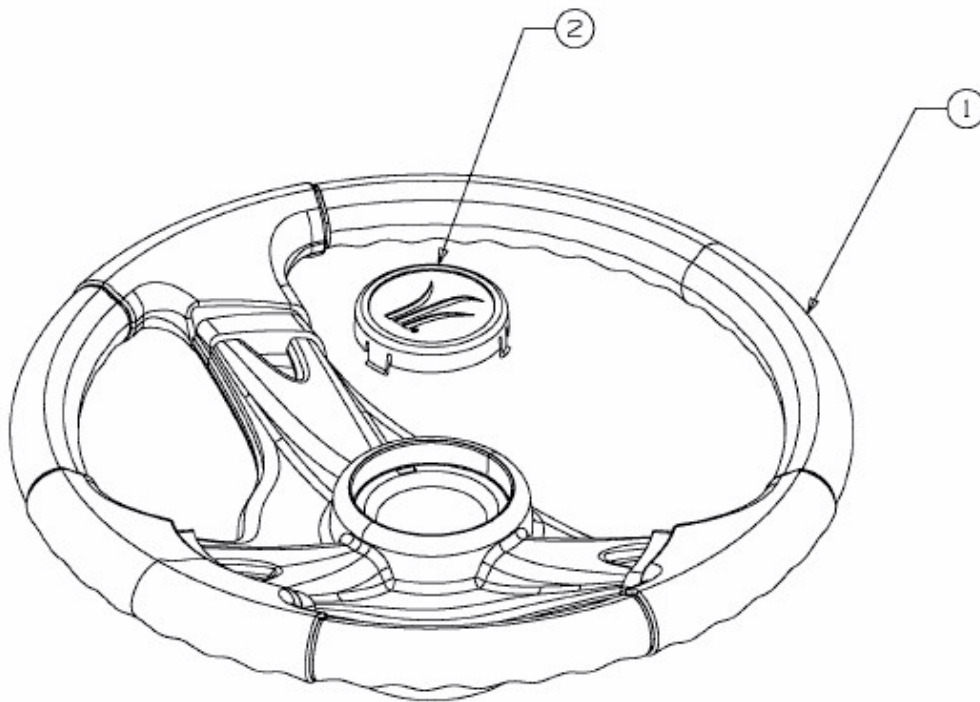

E3-02014A-01