

155-96 > 13AM777F615 (2009) > GESCHWINDIGKEITSREGELUNG, PEDALE

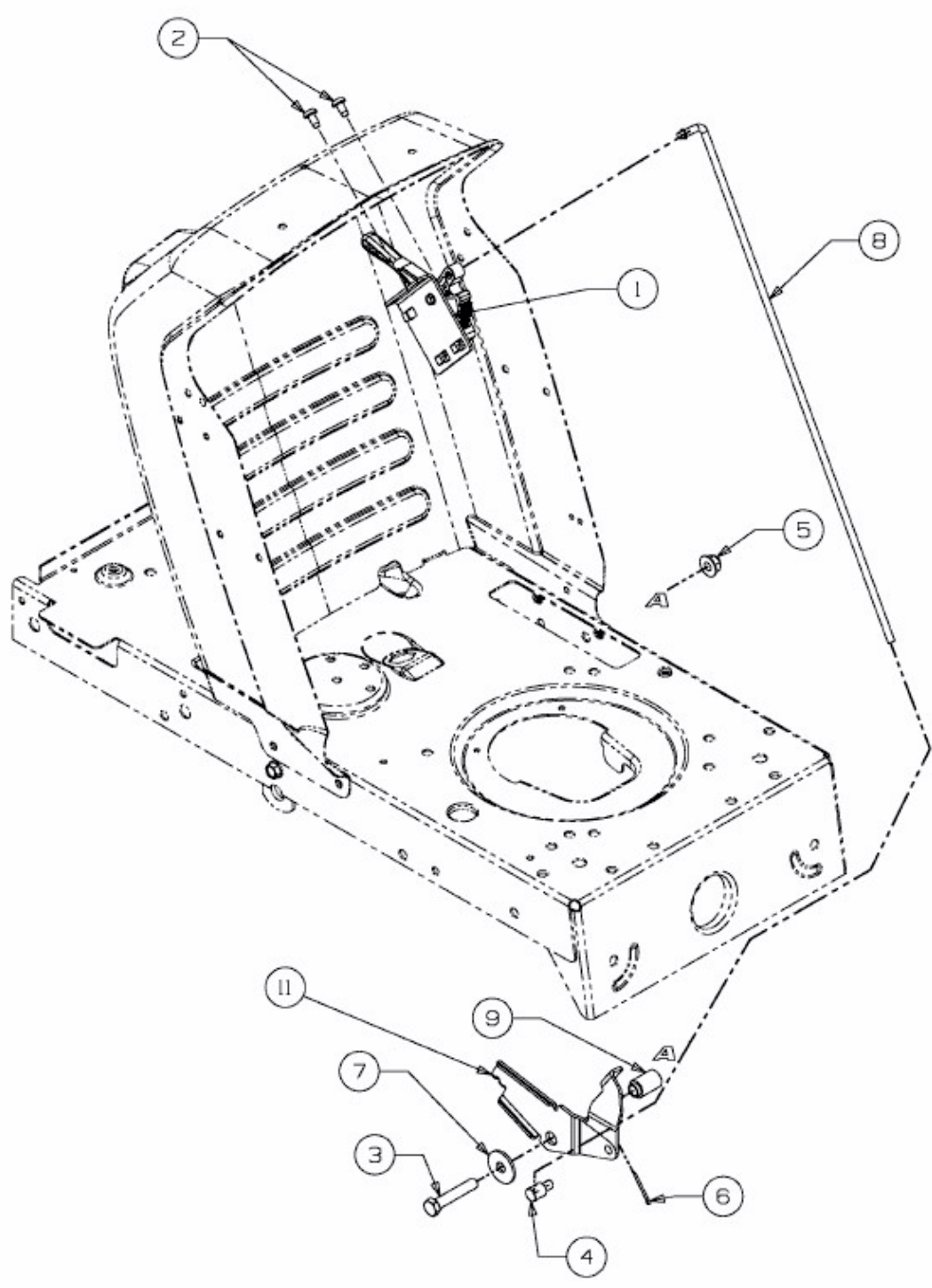

E3-02719C-01