

155-96 > 13AM777F615 (2008) > BATTERIEHALTER, TANK AB 25.02.2008

ab 25.02.2008  
from 25.02.2008  
à partir du 25.02.2008

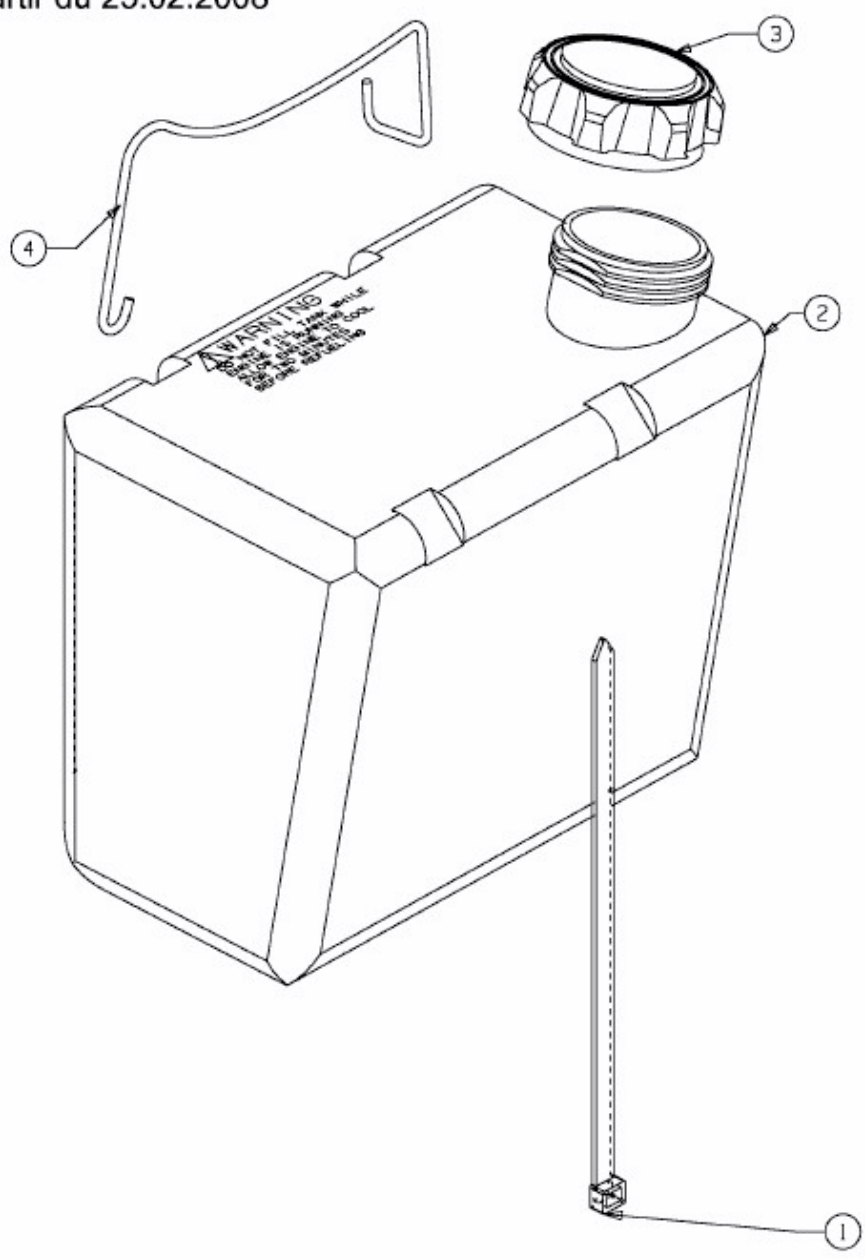

E3-02736D-01