

155-96 > 13AM777F615 (2008) > GETRIEBE, VARIATOR

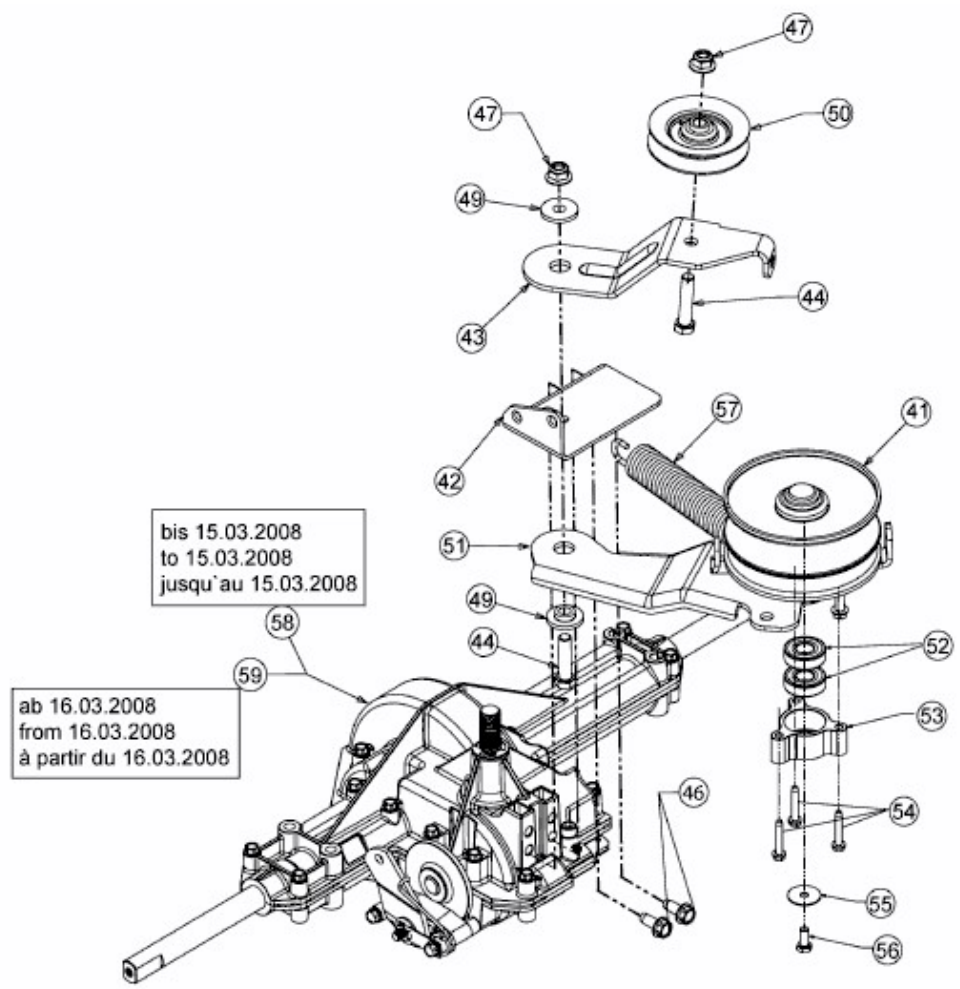

E3-02723C-02