

MASTERCUT 92-155 BIS 2016 > 13AM771E686 (2010) > FAHRANTRIEB, PEDALE

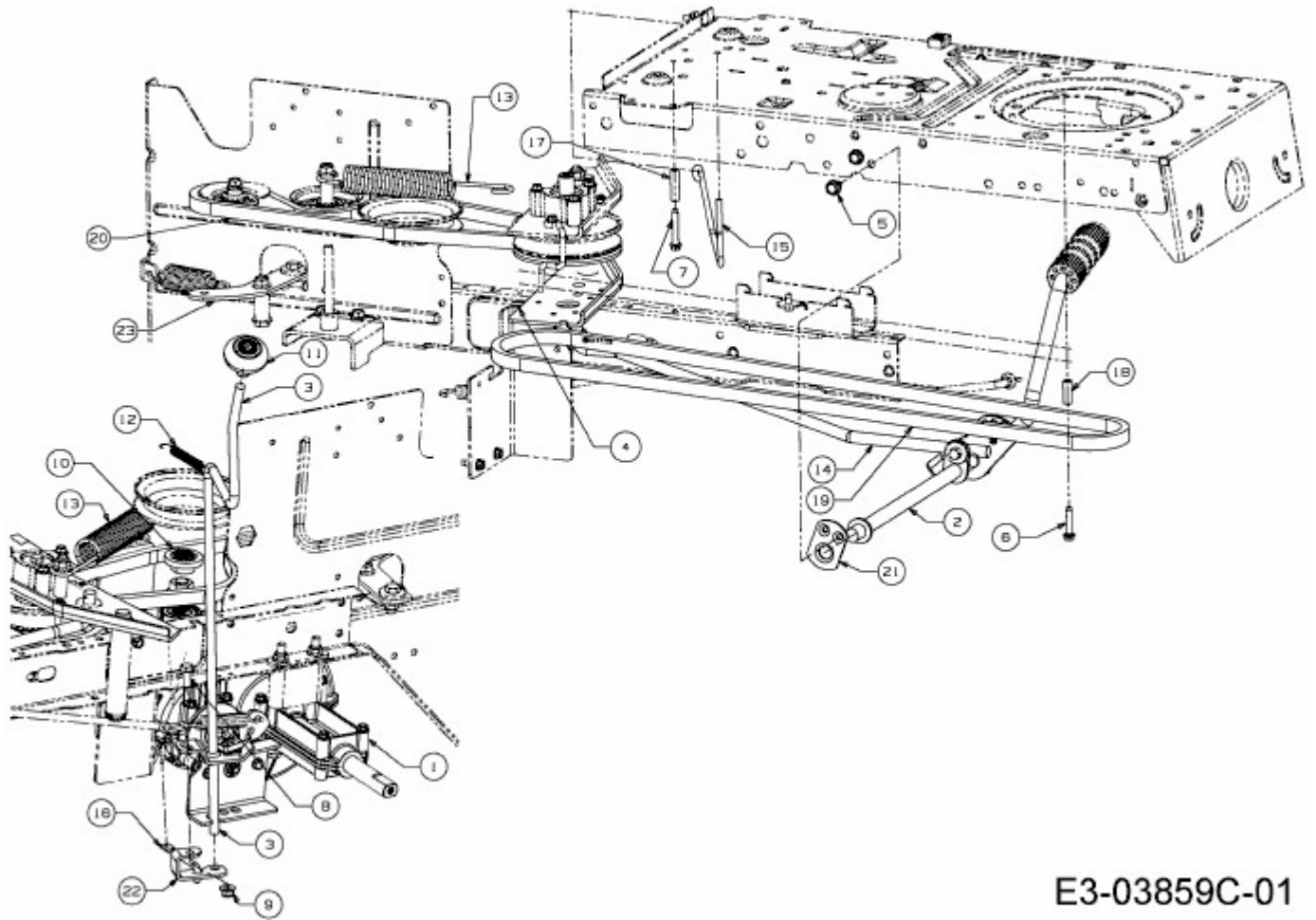

E3-03859C-01