

MASTERCUT 92-155 BIS 2016 > 13AM771E686 (2010) > GRASFANGVORRICHTUNG

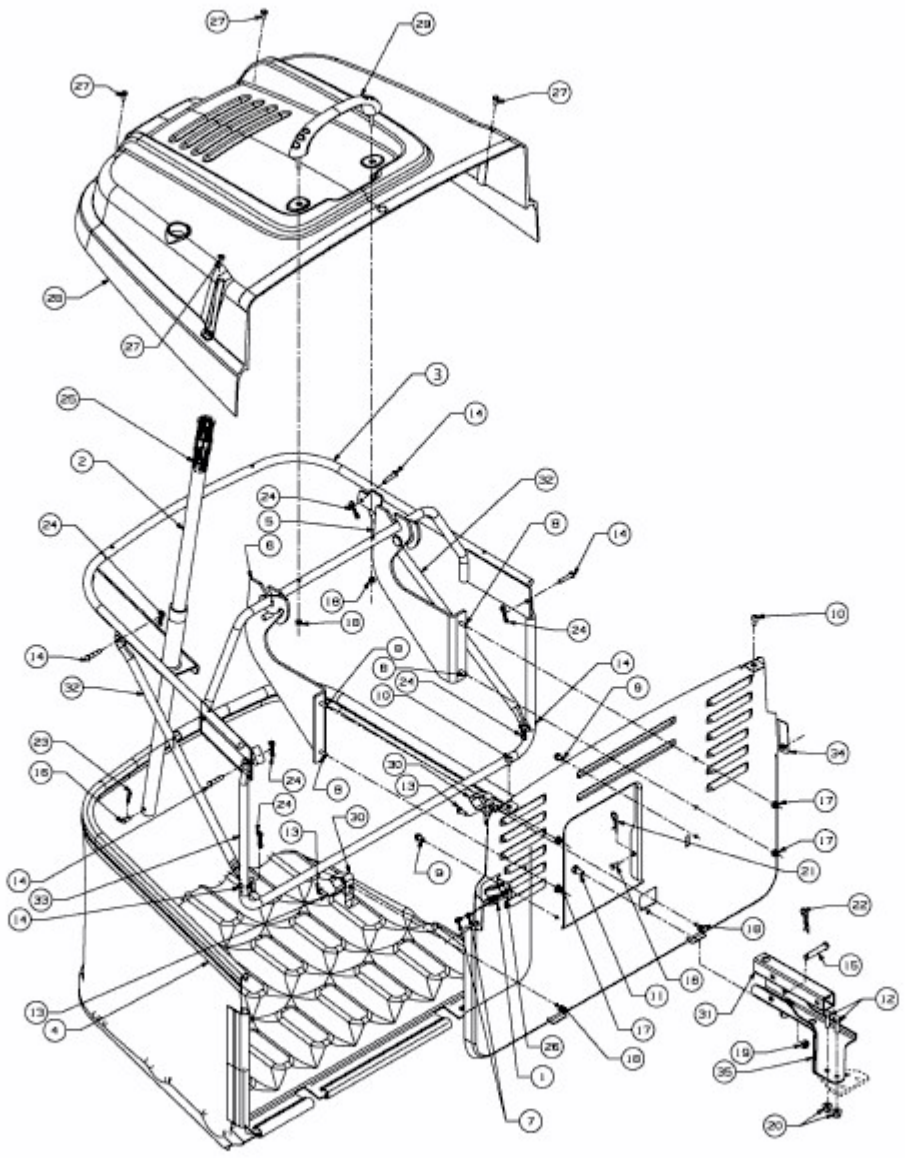

E3-03879B-01