

MASTERCUT 92-155 BIS 2016 > 13AM771E659 (2013) > GETRIEBE

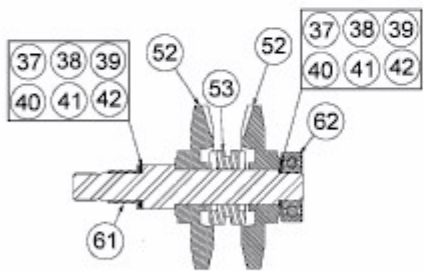

max. Axialspiel  
max. axial backlash  
max. jeu sur l'axe  
0,004" - 0,008"

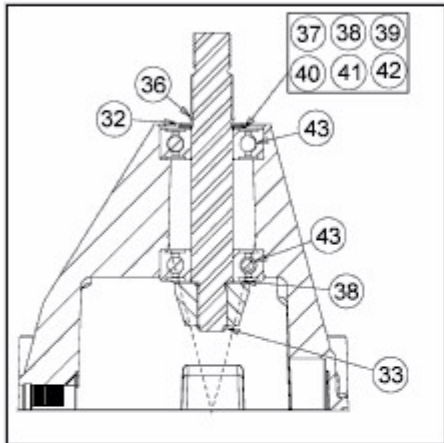
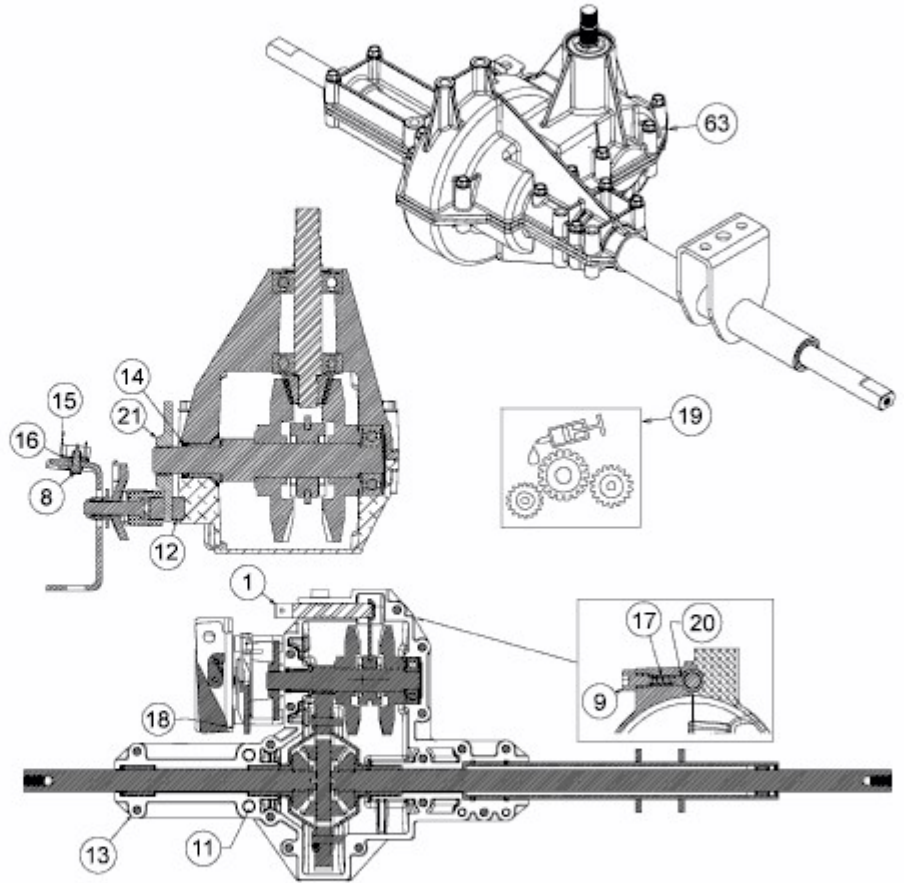

E3-03859D-02