

MASTERCUT 92-155 BIS 2016 > 13AM771E659 (2011) > GETRIEBE

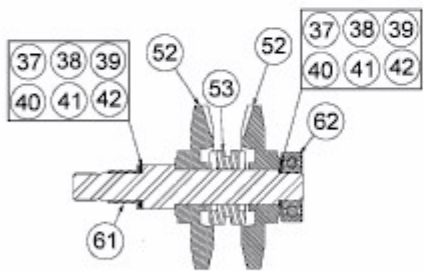

max. Axialspiel
max. axial backlash
max. jeu sur l'axe
0,004" - 0,008"

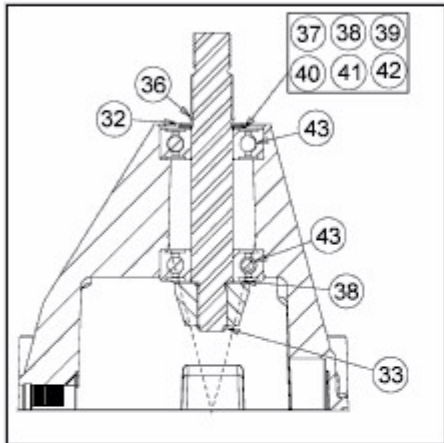
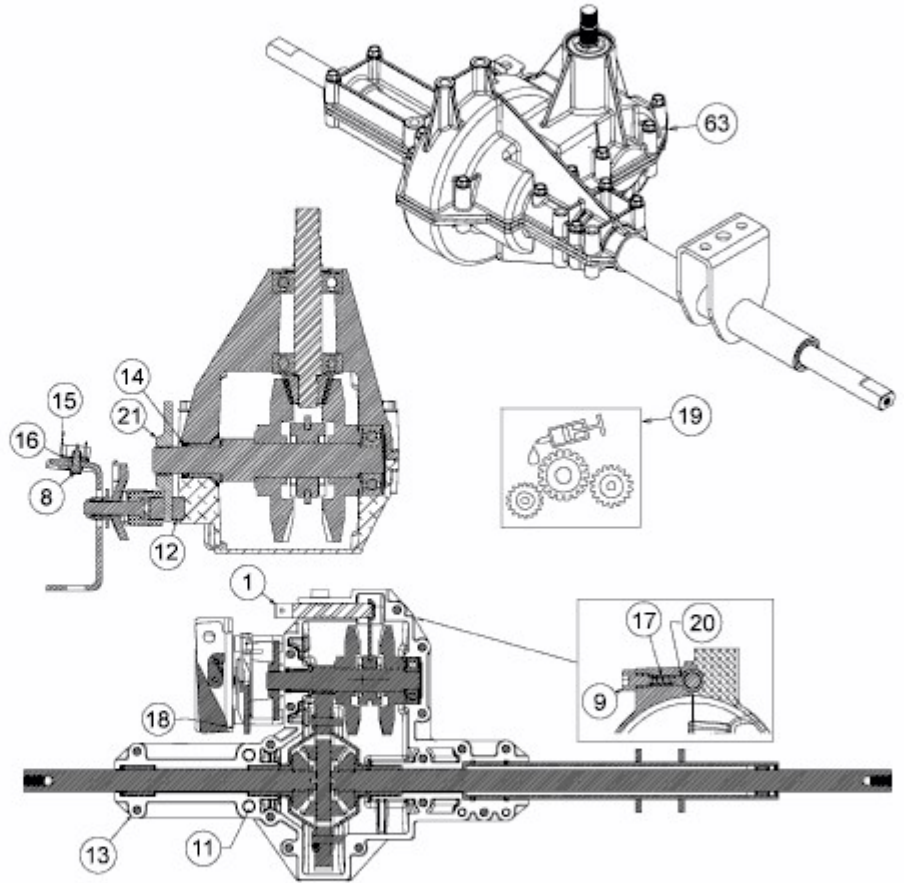

E3-03859D-02