

SL 155 BS > 13AM768G498 (2007) > MÄHWERKSEINSCHALTUNG,  
MOTORKEILRIEMENSCHIBE

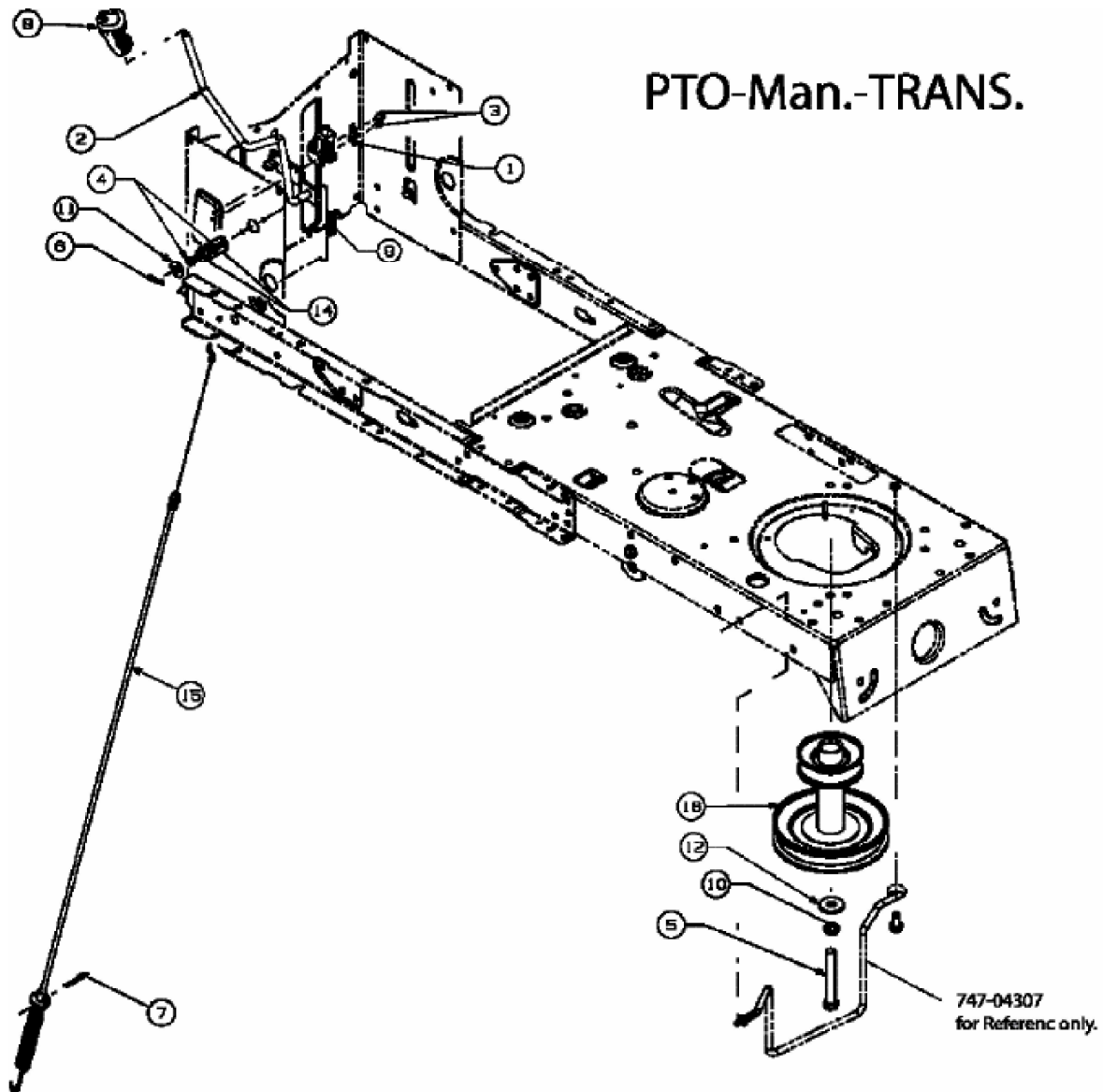

E3-02732B-01