

155/96 T > 13AM762F615 (2008) > CHOKEZUG

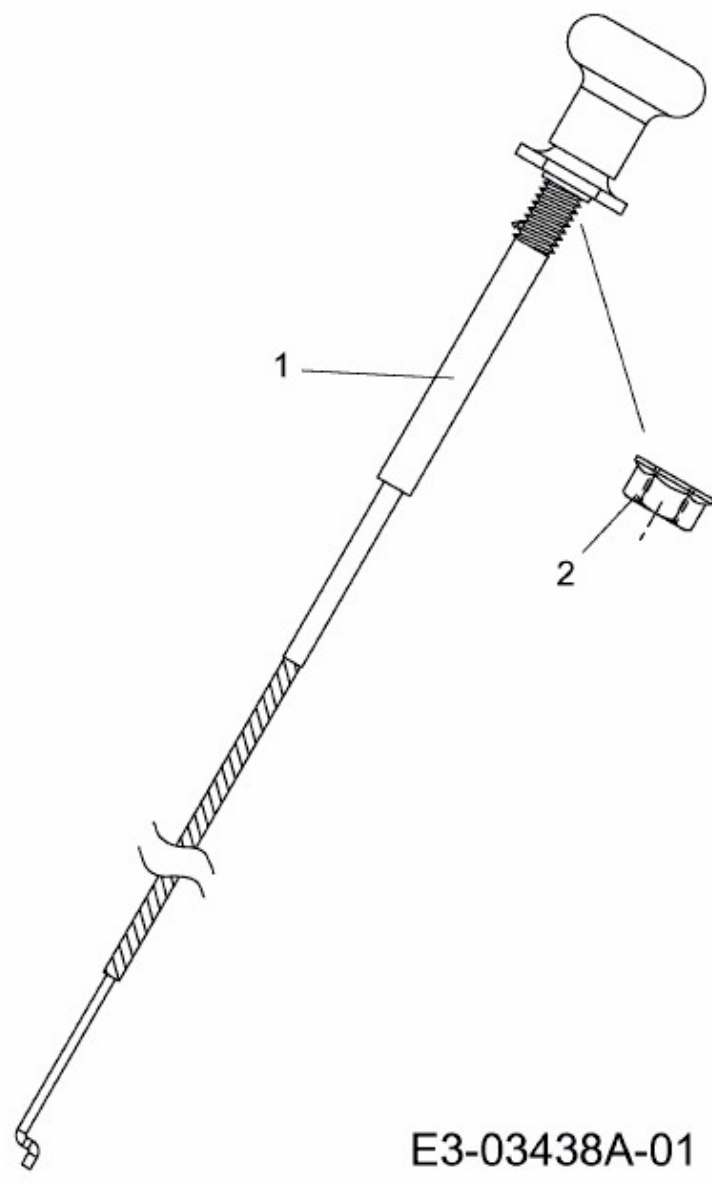

E3-03438A-01