

155/96 T > 13AM762F615 (2008) > DEFLEKTOR

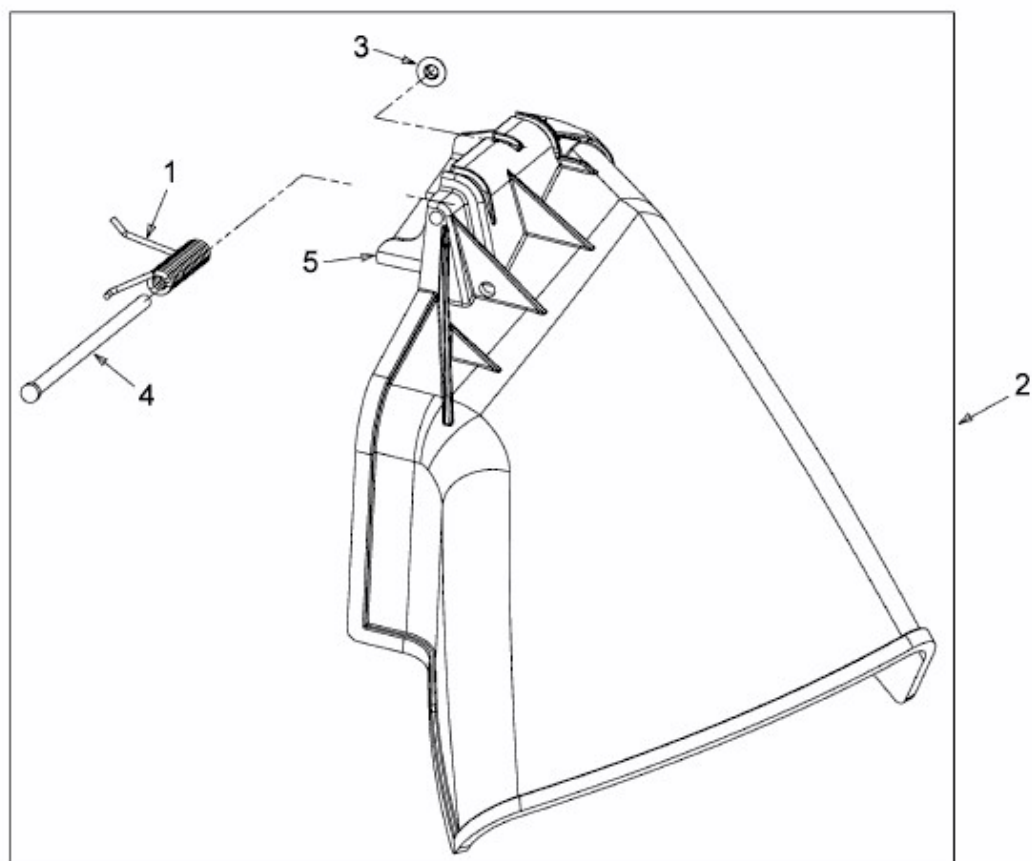

E3-02744A-01