

155/96 T > 13AM762F615 (2008) > GETRIEBE, VARIATOR

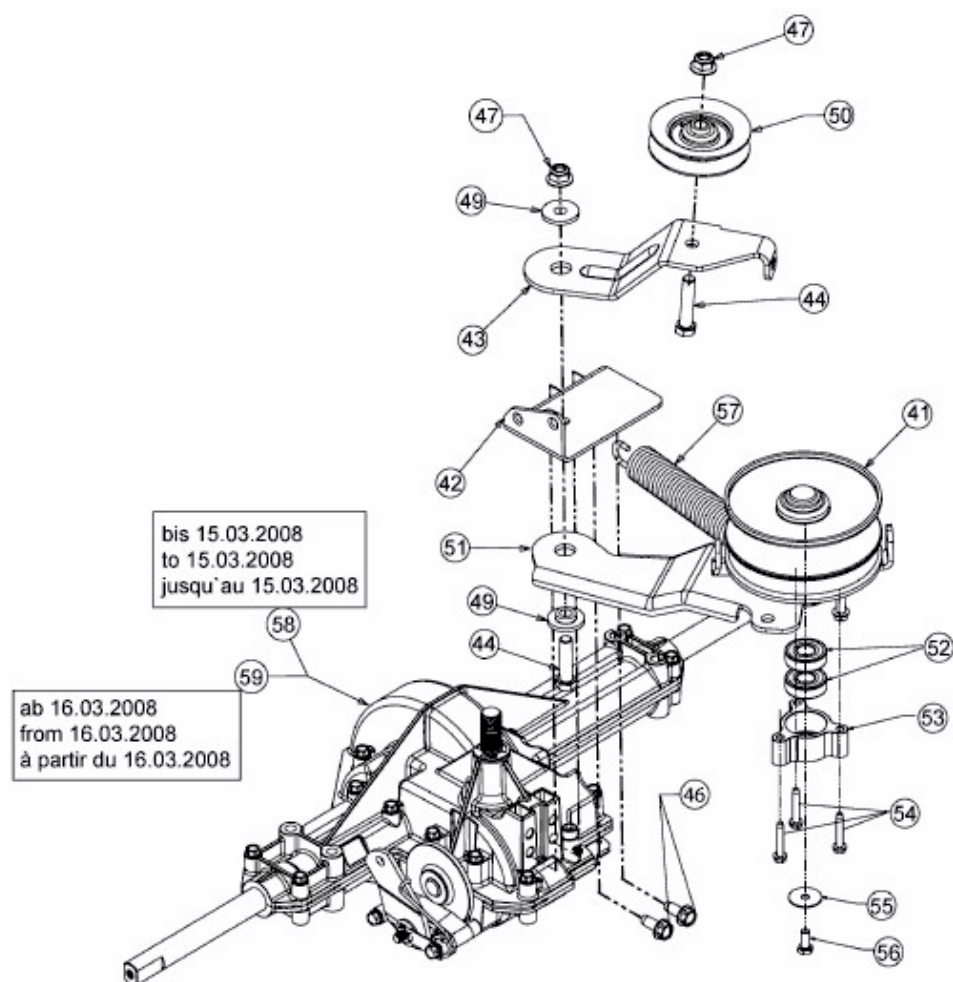

E3-02723C-02