

155/96 T > 13AM762F615 (2008) > GESCHWINDIGKEITSREGELUNG, PEDALE

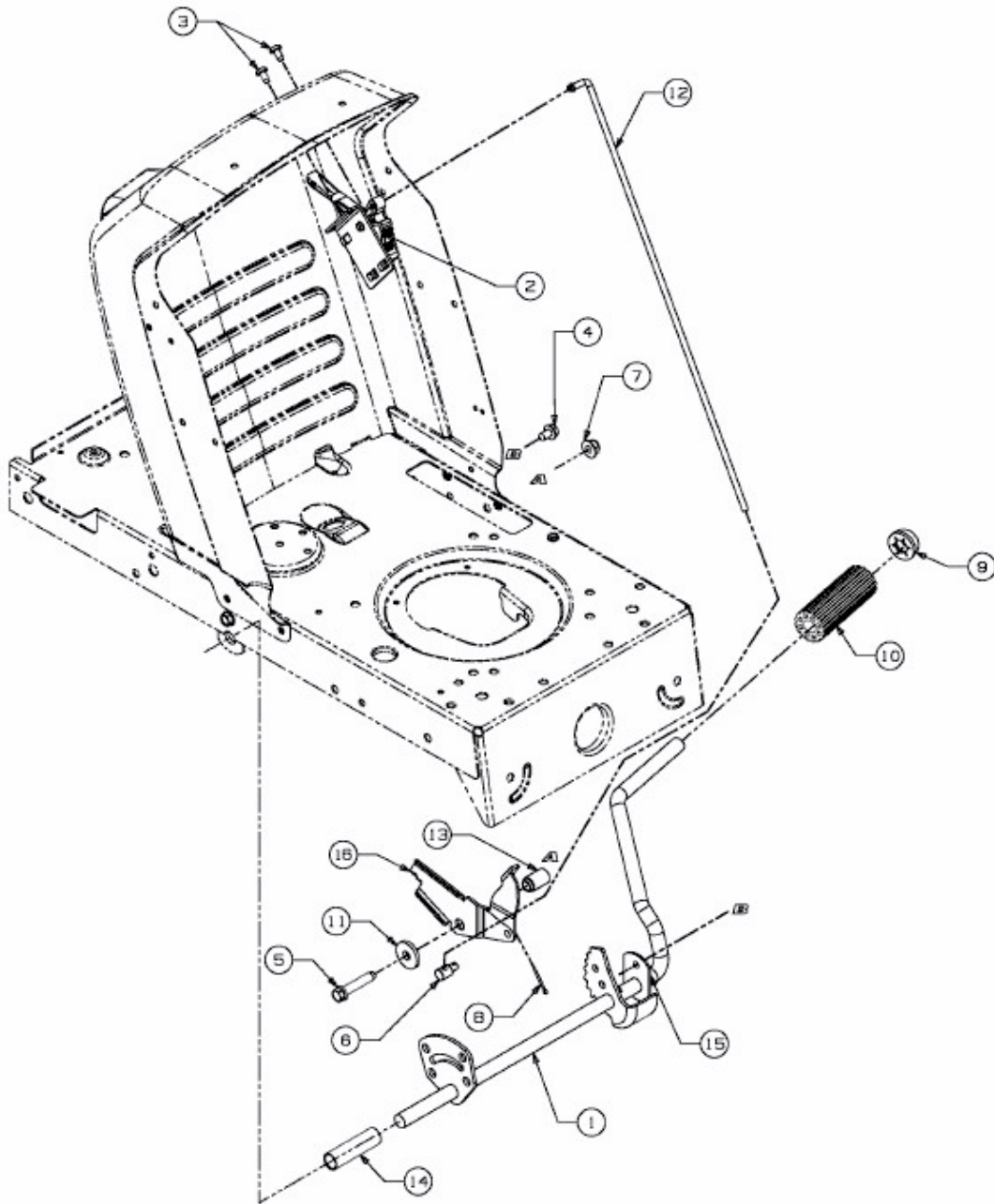

E3-02718A-01