

155/96 T > 13AM762F615 (2008) > LENKRAD

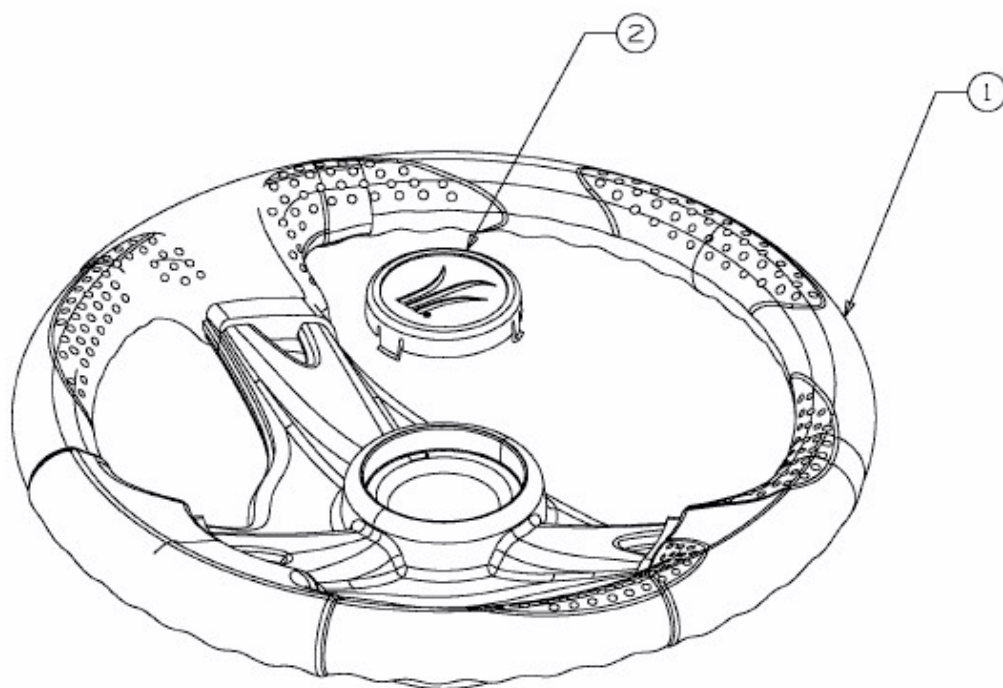

E3-02712A-01