

155/96 T > 13AM762F404 (2008) > RAHMEN

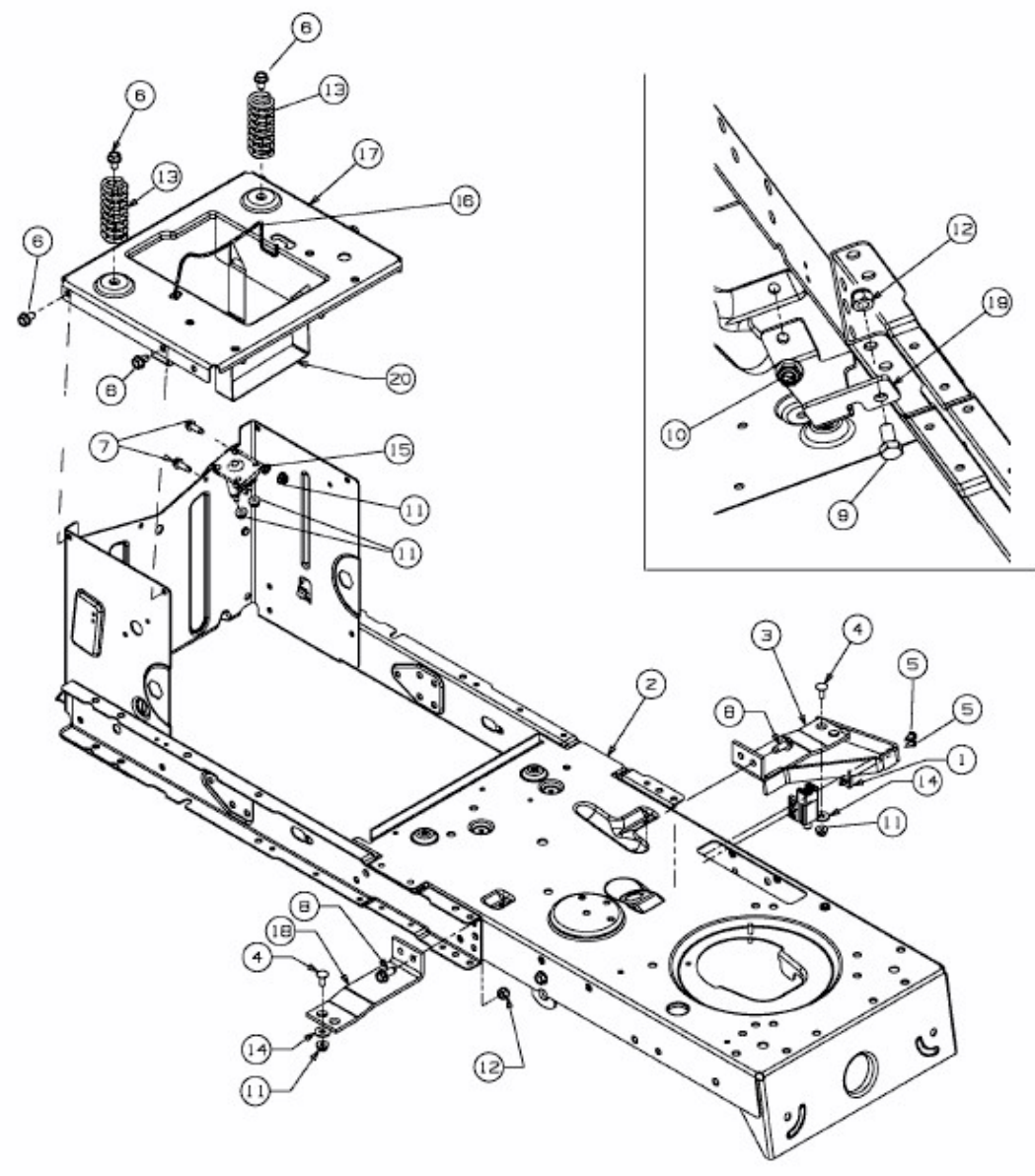

E3-02717B-01