

MASTERCUT 92-155 BIS 2016 > 13AM761E659 (2013) > GESCHWINDIGKEITSREGELUNG

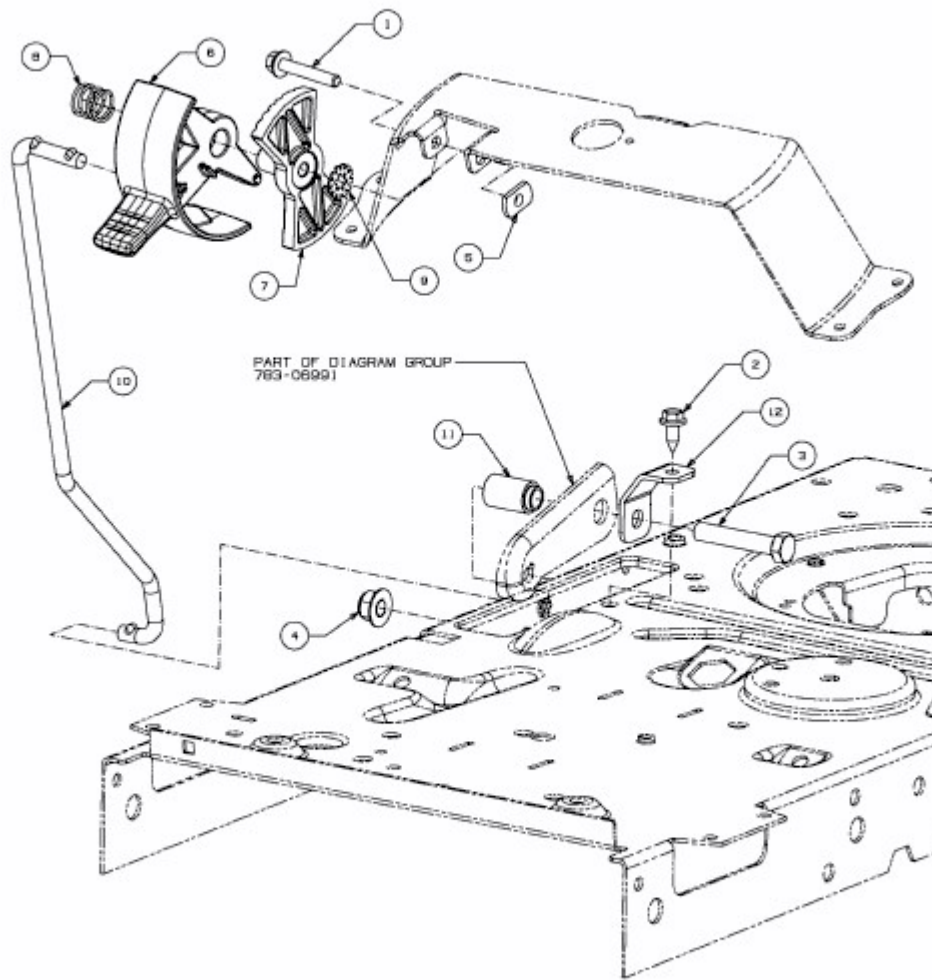

E3-07438B-01