

MASTERCUT 92-155 BIS 2016 > 13AM761E659 (2013) > TANK

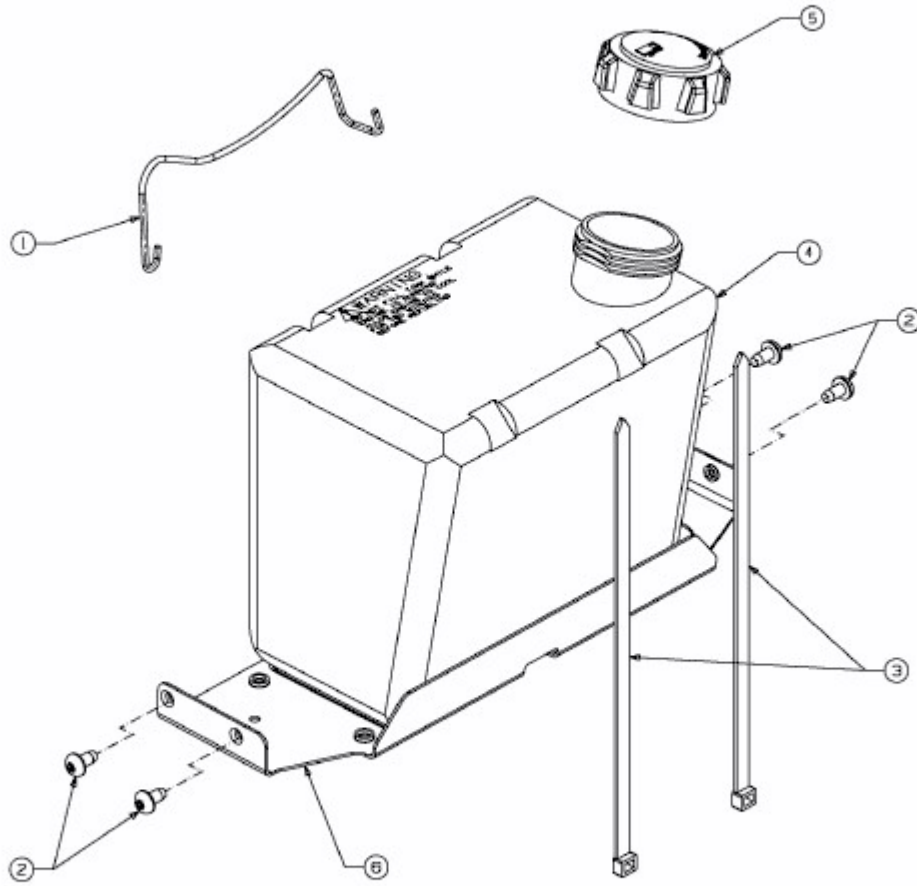

E3-07426A-01