

MASTERCUT 105 > 13AM760N659 (2008) > GESCHWINDIGKEITSREGELUNG, PEDALE

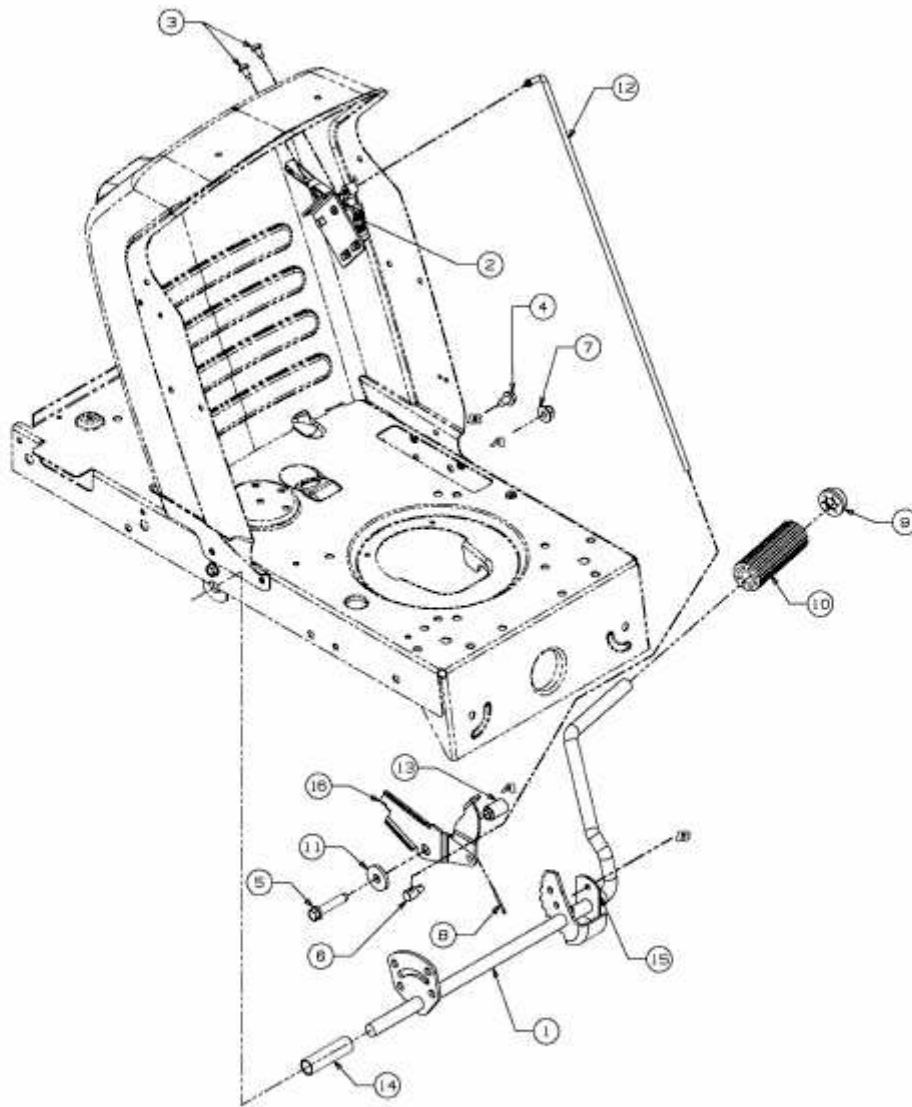

E3-02718A-01