

MASTERCUT 105 > 13AM760N459 (2008) > LENKRAD MIT LOGO

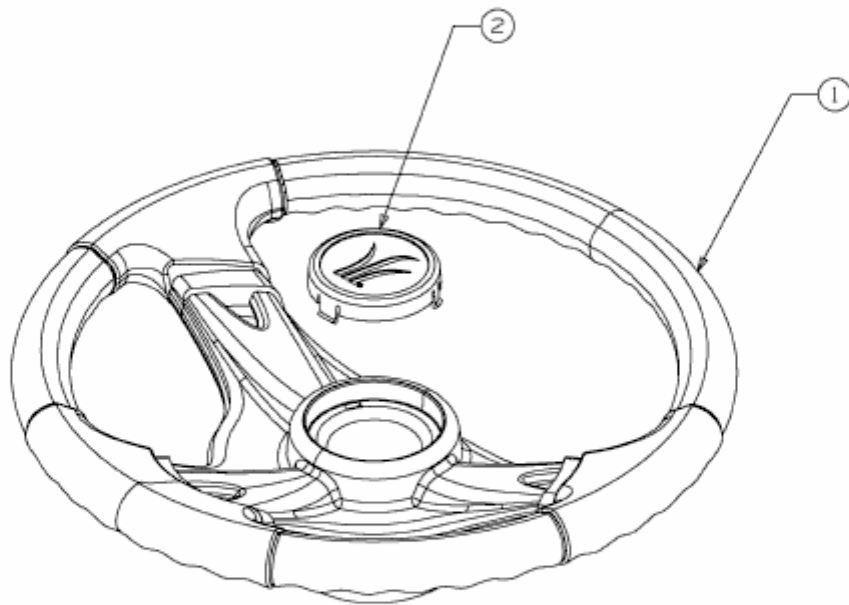

E3-02014A-01