

B 12596 > 13AL475F608 (1999) > MÄHWERKSAUSHEBUNG

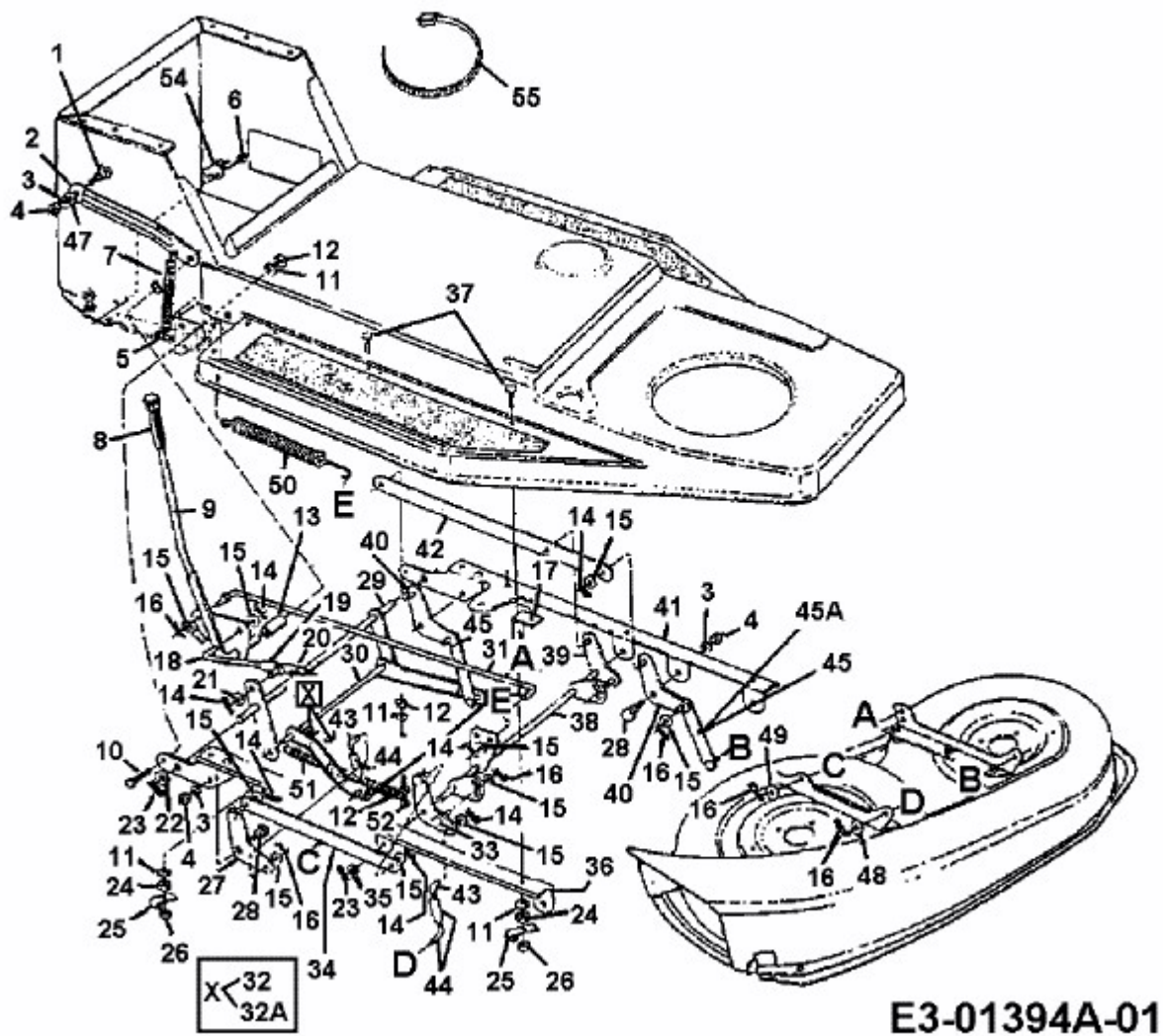

E3-01394A-01