

ab 11.03.2013
from 11.03.2013
à partir du 11.03.2013

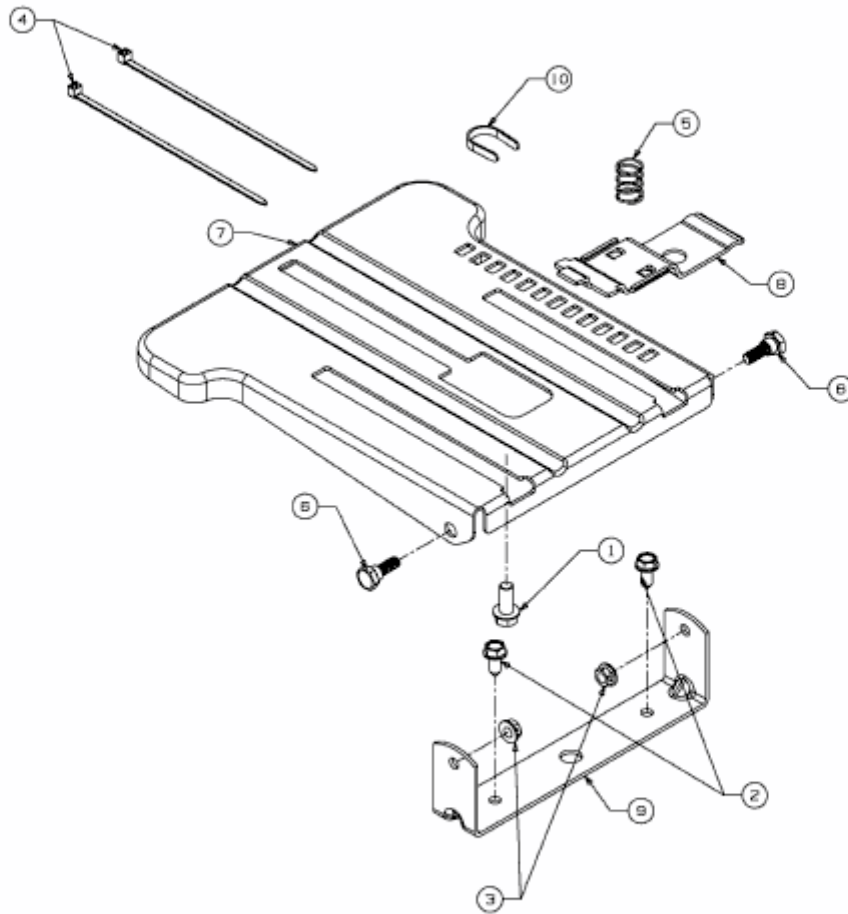

E3-04512D-02