

J 5250 K > 13AI51YJ643 (2009) > SITZTRÄGER

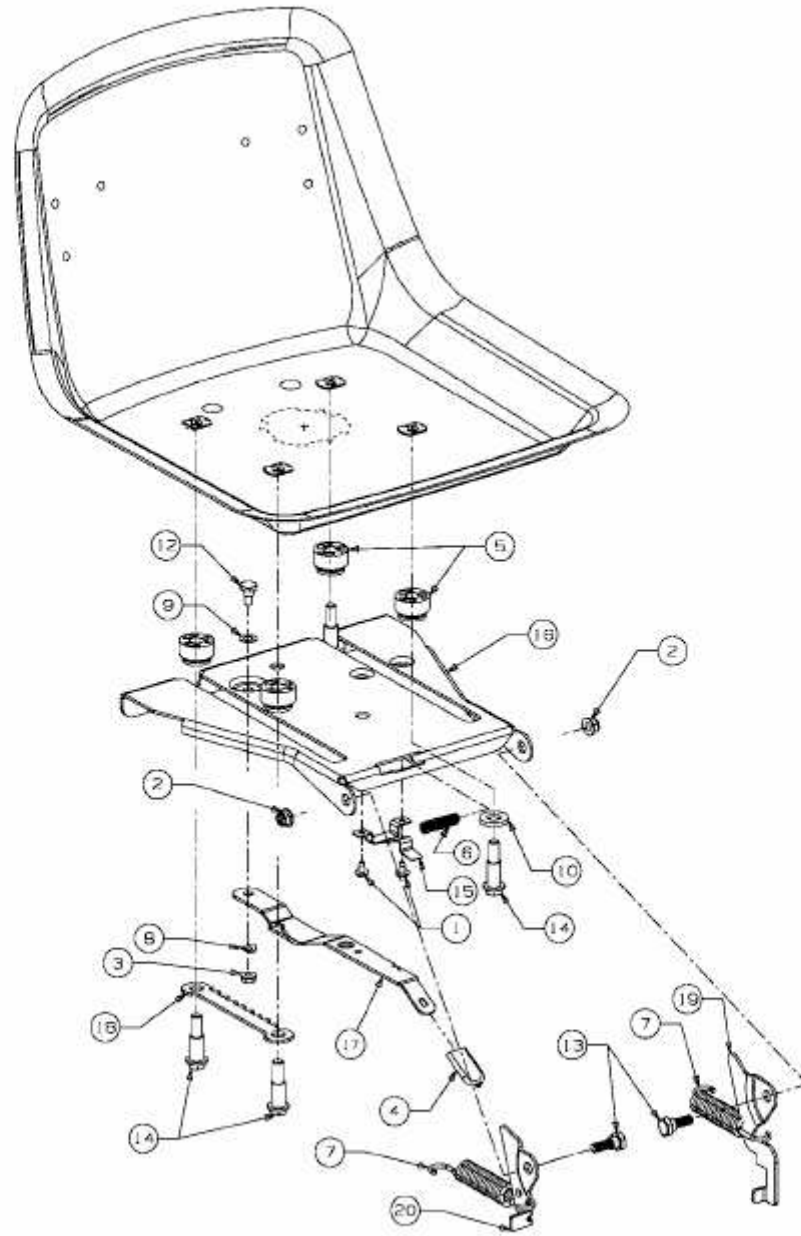

E3-02342B-01