

J 5250 K > 13AI51YJ443 (2009) > FÜLLSTANDSANZEIGE

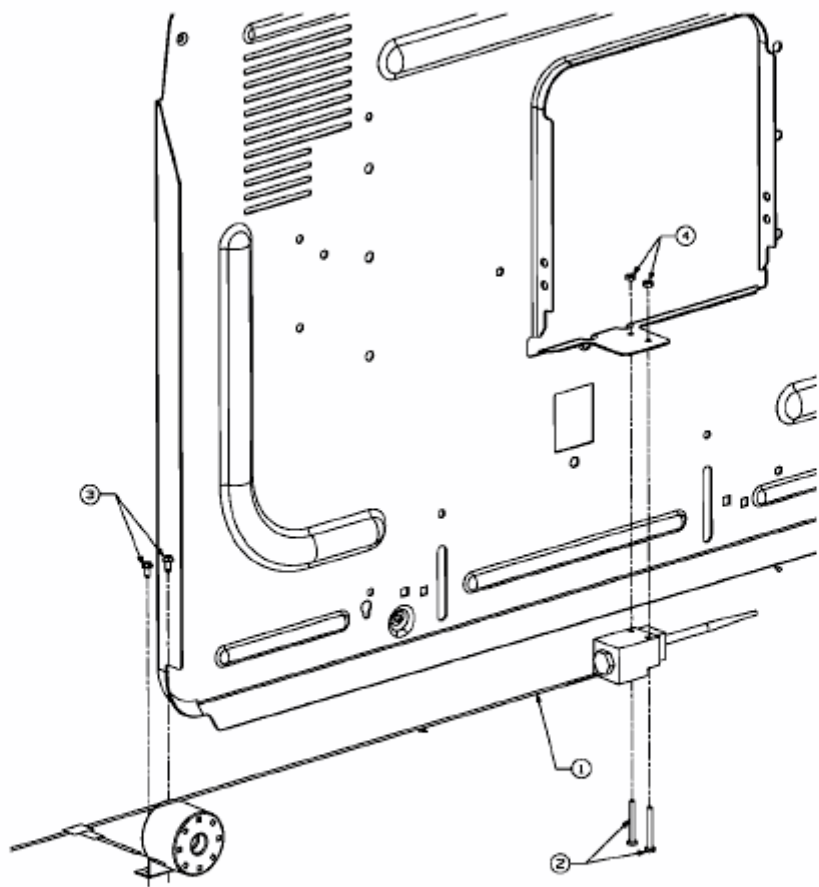

E3-02081B-01