

GL 13,5-92 H > 13AH993E640 (2013) > AUSGLEICHSBEHÄLTER, HYDROSTAT

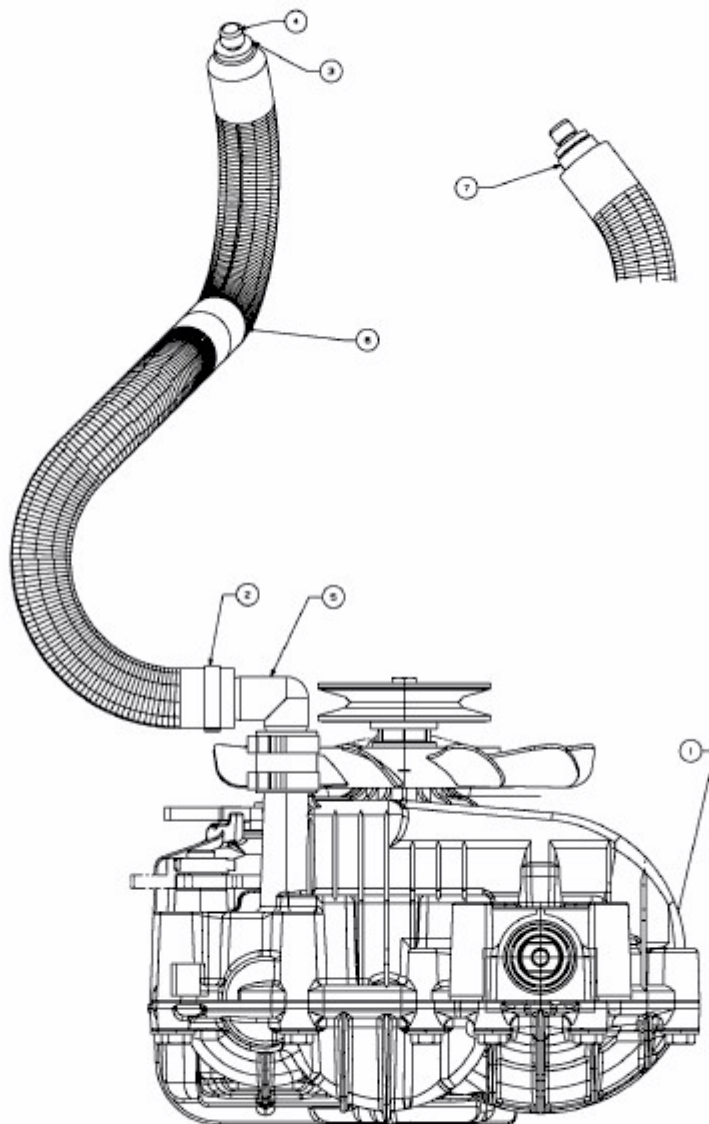

E3-07522A-02