

KOMMAND 80/12,5 T > 13AH77KC637 (2011) > GESCHWINDIGKEITSREGELUNG

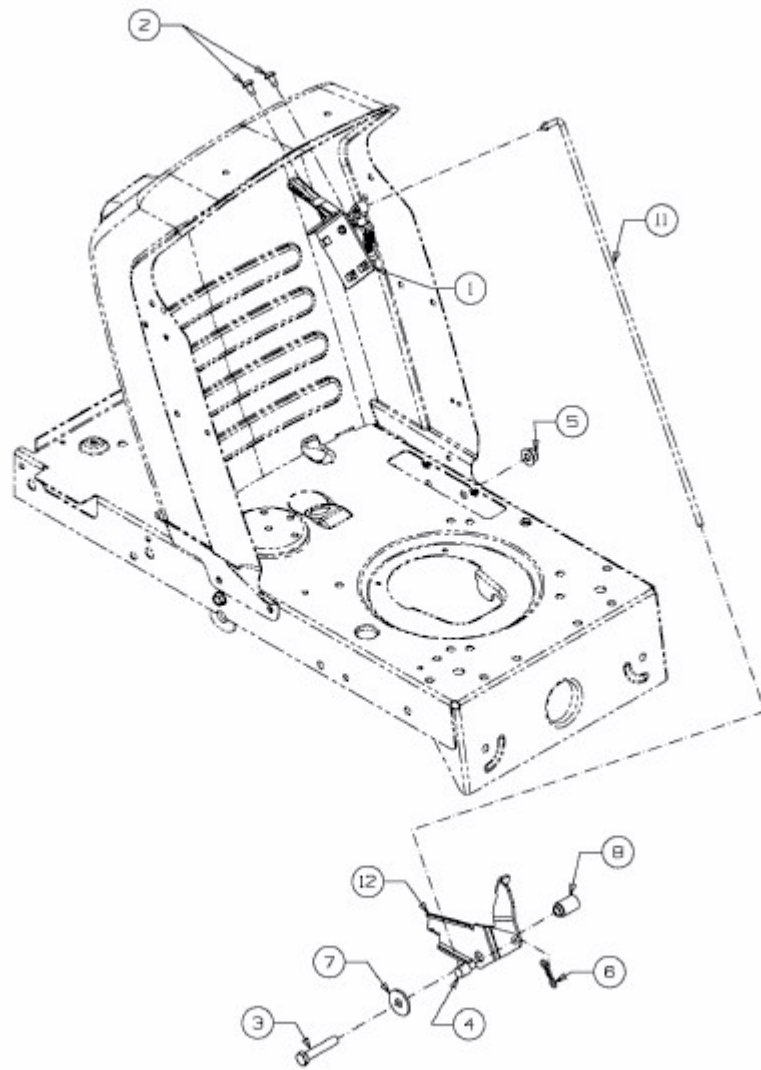

E3-02719D-01