

KROSSER 80/12,5 T > 13AH77KC636 (2010) > SCHALTPLAN

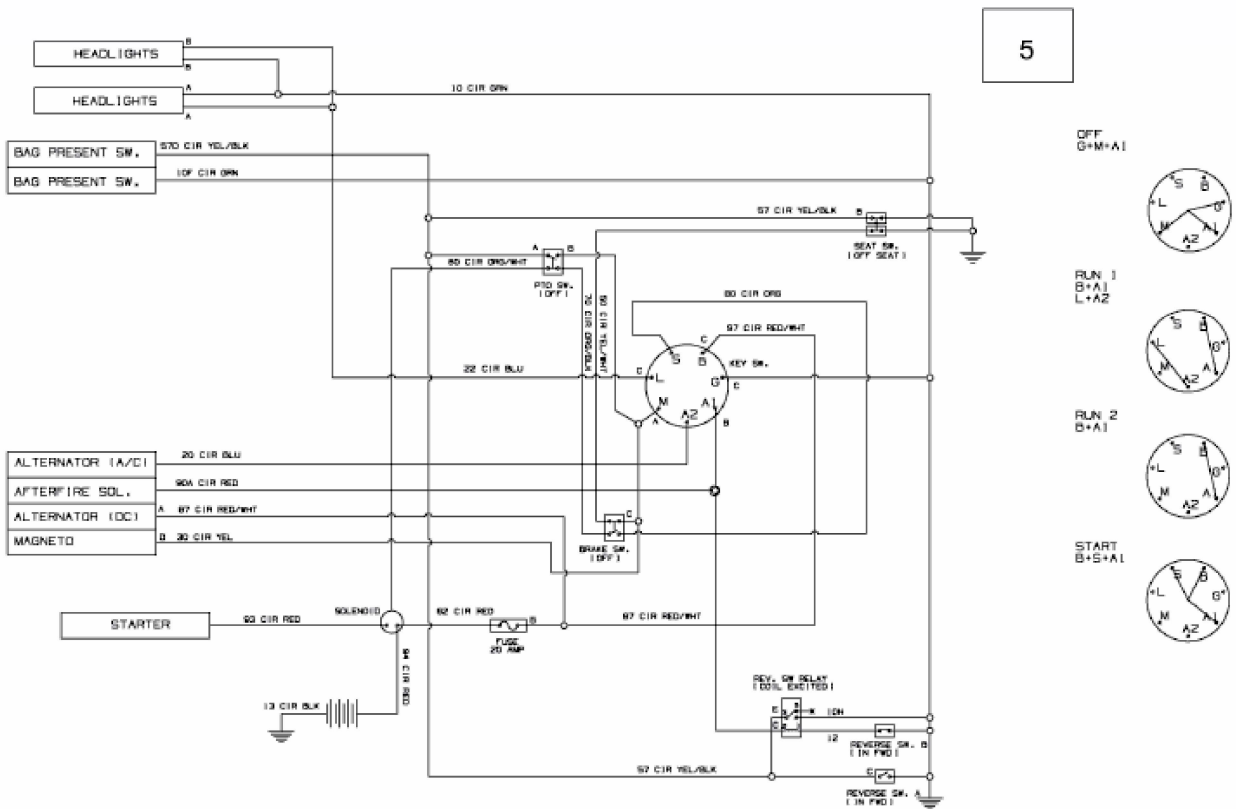

E3-03888D-02