

FORMULA 97/13.5 T > 13AH779F637 (2007) > LENKUNG

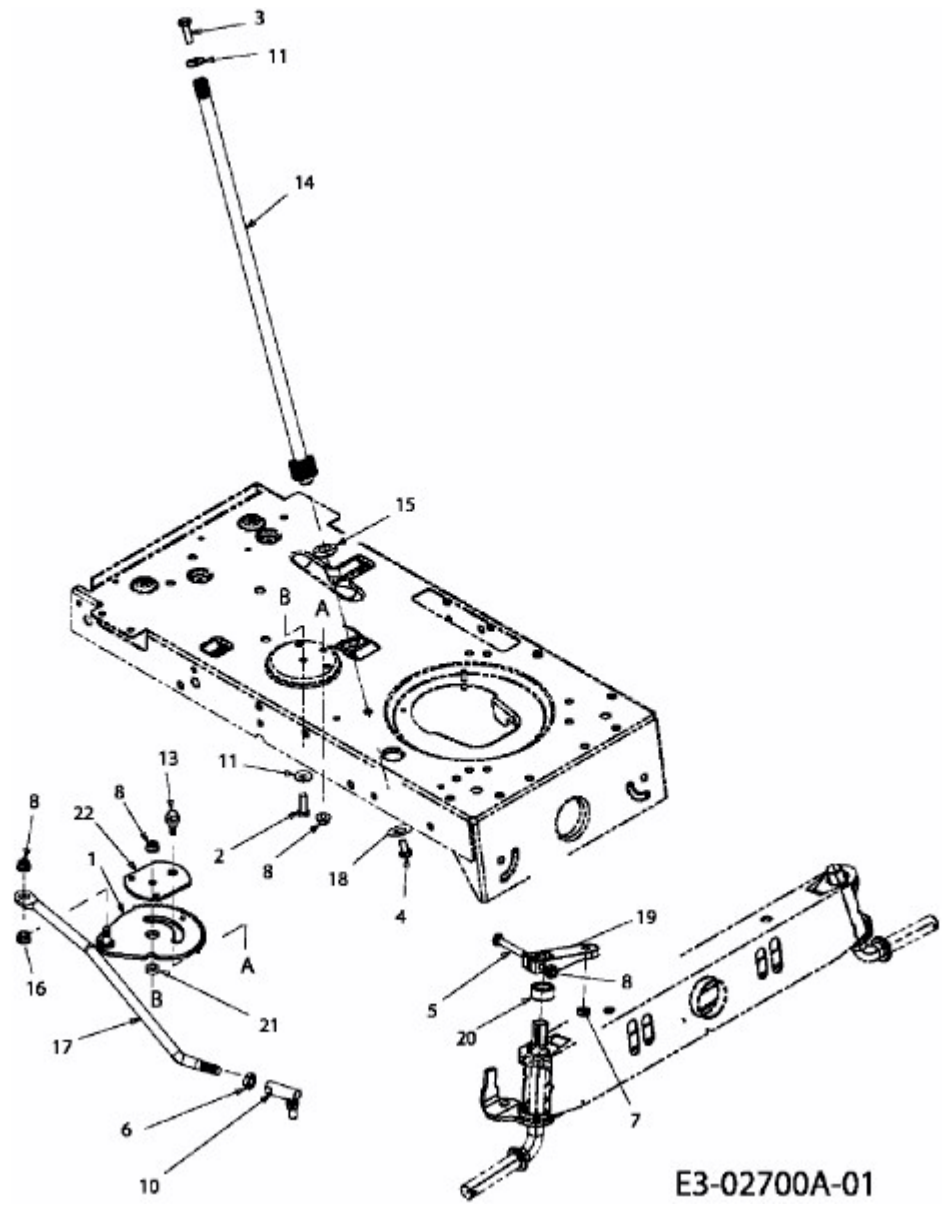

E3-02700A-01