

FORMULA 97/13 T > 13AH779F637 (2008) > RAHMEN

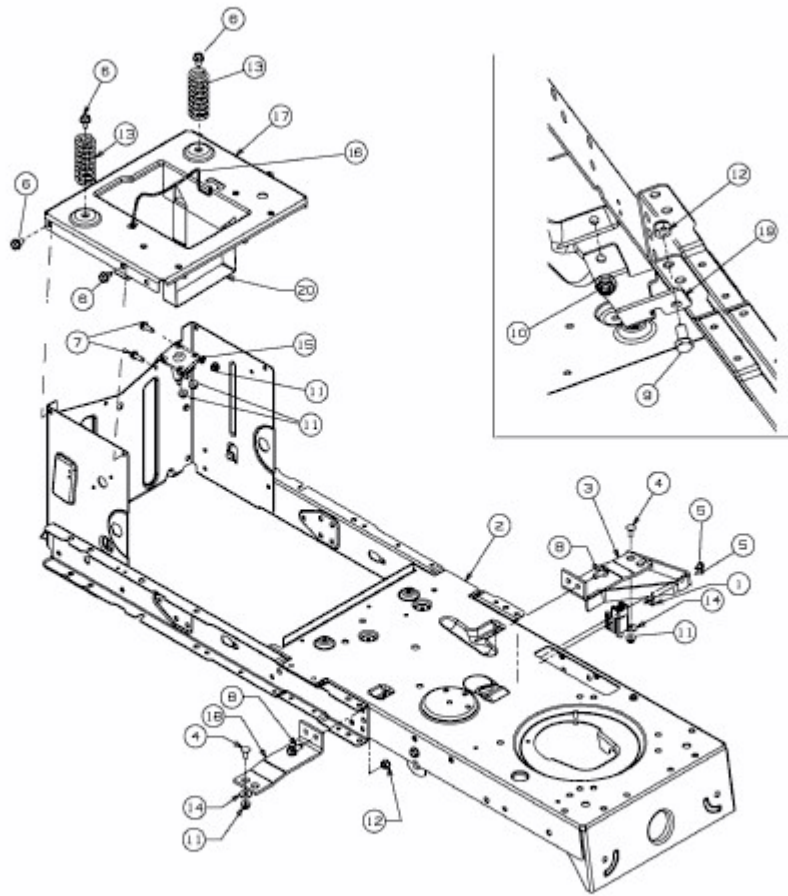

E3-02717B-01