

ab 29.02.2008
from 29.02.2008
à partir du 29.02.2008

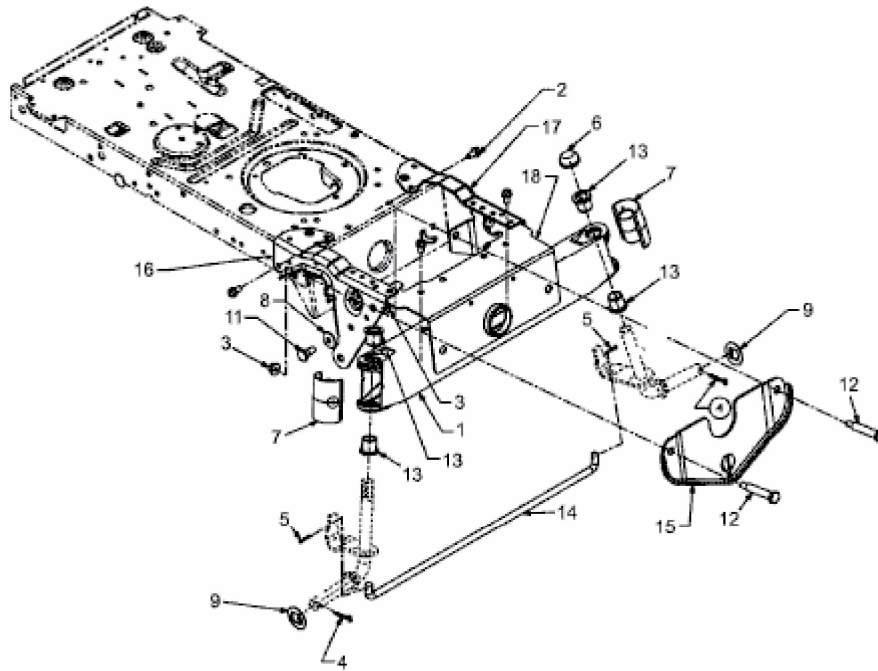

E3-02702B-01